

Instructions for Use

Advantix Vario standing grate set



suitable for Advantix Vario end closing piece model 4965.16,
Advantix Vario 90° connection piece model 4965.14

Model
4965.62

Year built (from)
07/2013

Table of contents

1	About these instructions for use	3
	1.1 Target groups	3
	1.2 About this translated version	3
	1.3 Other applicable documents	3
2	Product information	4
	2.1 Standards and regulations	4
	2.2 Product description	4
	2.2.1 Overview	5
3	Handling	6
	3.1 Assembly	6
	3.2 Disposal	7

1 About these instructions for use

Trade mark rights exist for this document, further information can be found at viega.com/legal.

1.1 Target groups

The information in this instruction manual is directed at the following groups of people:

- Heating and sanitary professionals and trained personnel
- Tilers

It is not permitted for individuals without the abovementioned training or qualification to mount, install and, if required, maintain this product. This restriction does not extend to possible operating instructions.

The installation of Viega products must take place in accordance with the general rules of engineering and the Viega instructions for use.

1.2 About this translated version

This instruction for use contains important information about the choice of product or system, assembly and commissioning as well as intended use and, if required, maintenance measures. The information about the products, their properties and application technology are based on the current standards in Europe (e. g. EN) and/or in Germany (e. g. DIN/DVGW).

Some passages in the text may refer to technical codes in Europe/ Germany. These should serve as recommendations in the absence of corresponding national regulations. The relevant national laws, standards, regulations, directives and other technical provisions take priority over the German/European directives specified in this manual: The information herein is not binding for other countries and regions; as said above, they should be understood as a recommendation.

1.3 Other applicable documents

This instruction for use describes the mounting of an accessory set for an Advantix Vario shower channel in rough steps.



The instructions for use of the Advantix Vario shower channel must also be strictly observed for the mounting of the accessory set.

2 Product information

2.1 Standards and regulations

The following standards and regulations apply to Germany / Europe. National regulations can be found on the relevant web site of your country at viega.com/standards.

Regulations from section: Sealing

Scope / Notice	Regulations applicable in Germany
Stress class of the underground, as well as suitable bonded sealing	ZDB-Merkblatt 8/2012
Stress class of the underground, as well as suitable bonded sealing	Leitfaden zur Abdichtung im Verbund (AIV)
Approved bonded sealings with proof of practicability in keeping with building law for stress classes A and AO	ETAG 022 T1
Approved bonded sealings with proof of practicability in keeping with building law for stress classes A, B and C	DIBt-Bauregelliste A, Teil 2 des DIBt und Prüfgrundsätze für Abdichtungen im Verbund (PG AIV-F)
Permitted bonded sealings	EN 14891

Regulations from section: Media

Scope / Notice	Regulations applicable in Germany
Typical domestic wastewater	DIN 1986-3

2.2 Product description

The standing grate set may only be mounted in Viega Advantix Vario shower channel model 4965.10.

Model	4965.62
Article	711 856
Description	Advantix Vario standing grate set, complete accessories with cover cap

2.2.1 Overview

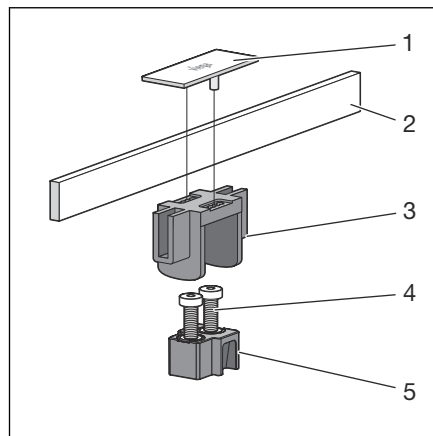
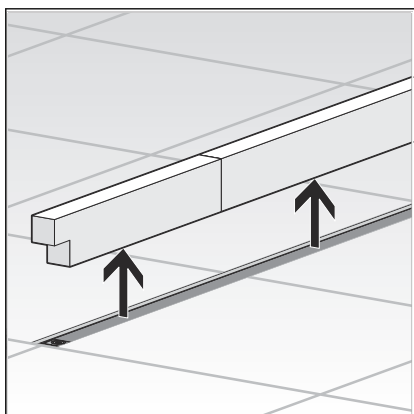

Fig. 1: Scope of delivery

- 1 - cover cap
- 2 - standing grate
- 3 - grate holder
- 4 - screws
- 5 - connector insert

3 Handling

3.1 Assembly



- Remove protective insert.

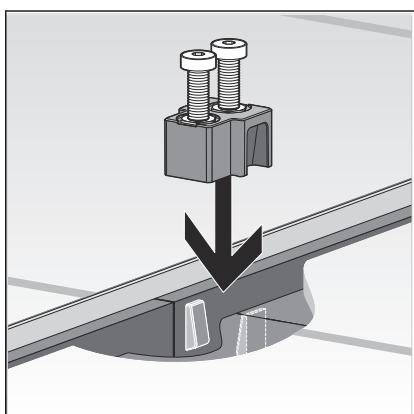

- Insert the connector insert with the screws.

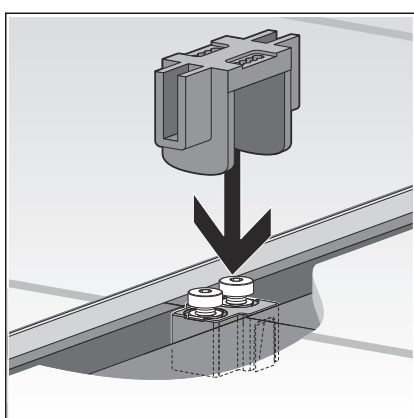

- Place the grate holder onto the screw and adjust to tile height.
The maximum height of the standing grate is 20 mm above the flange.
When using the natural stone set, the maximum height of the standing grate is 30 mm above the flange.

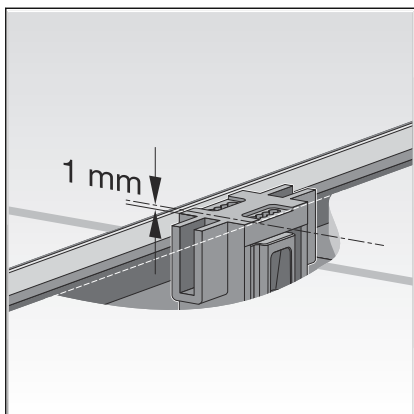

- The upper edge of the grate holder must be approx. 1 mm below the upper edge of the tiles.

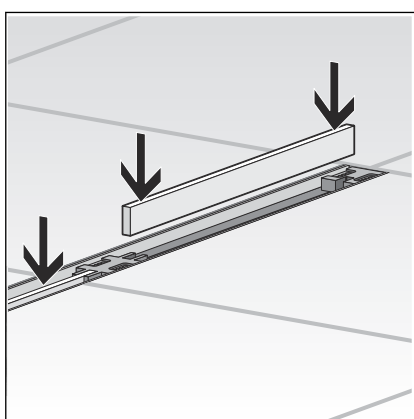

- Insert the standing grates.

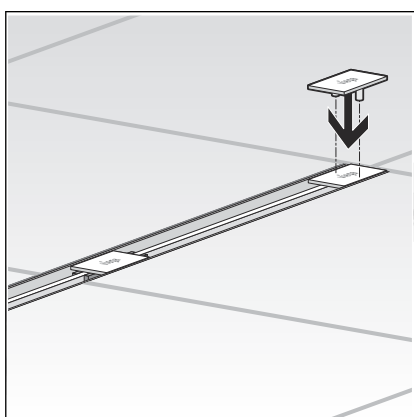

- Push in the cover cap.
The cover caps can be moved by up to 5.6 mm.

3.2 Disposal

Separate the product and packaging materials (e. g. paper, metal, plastic or non-ferrous metals) and dispose of in accordance with valid national legal requirements.



Viega GmbH & Co. KG
service-technik@viega.de
viega.com

INT • 2022-08 • VPN170347

