

Instructions for Use

Advantix Vario shower channel standing grate

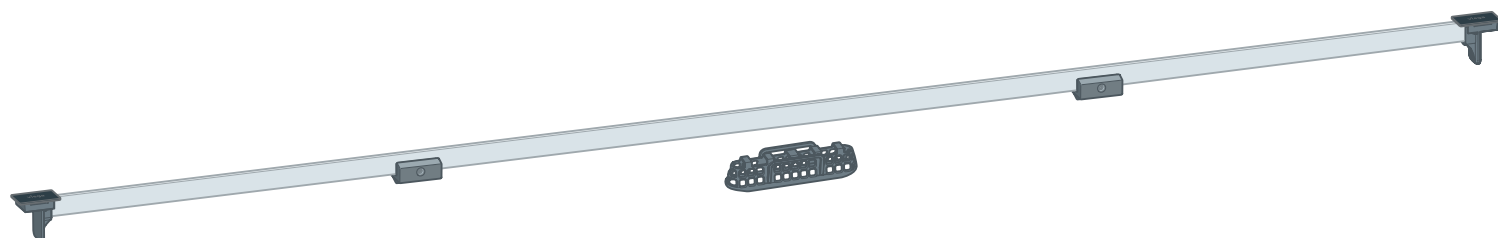

for Advantix Vario shower channel base unit model 4965.10,
4966.10

Model
4965.33

Year built (from)
11/2011

viega

Table of contents

1	About these instructions for use	3
	1.1 Target groups	3
	1.2 Labelling of notes	3
	1.3 About this translated version	4
	1.4 Other applicable documents	4
2	Product information	5
	2.1 Standards and regulations	5
	2.2 Certification	5
	2.3 Product description	5
	2.3.1 Overview	6
3	Handling	7
	3.1	7
	3.1.1 Installation dimensions	7
	3.2 Assembly	8
	3.2.1 Care	11
	3.3 Disposal	11

1 About these instructions for use

Trade mark rights exist for this document; for further information, go to viega.com/legal.

1.1 Target groups

The information in this instruction manual is directed at the following groups of people:

- Heating and sanitary professionals and trained personnel

Individuals without the abovementioned training or qualification are not permitted to mount, install and, if required, maintain this product. This restriction does not extend to possible operating instructions.

The installation of Viega products must take place in accordance with the general rules of engineering and the Viega instructions for use.

1.2 Labelling of notes

Warning and advisory texts are set aside from the remainder of the text and are labelled with the relevant pictographs.



DANGER!

This symbol warns of possible life-threatening injury.



WARNING!

This symbol warns of possible serious injury.



CAUTION!

This symbol warns of possible injury.



NOTICE!

This symbol warns of possible damage to property.



This symbol gives additional information and hints.

1.3 About this translated version

This instruction for use contains important information about the choice of product or system, assembly and commissioning as well as intended use and, if required, maintenance measures. The information about the products, their properties and application technology are based on the current standards in Europe (e.g. EN) and/or in Germany (e.g. DIN/DVGW).

Some passages in the text may refer to technical codes in Europe/Germany. These should serve as recommendations in the absence of corresponding national regulations. The relevant national laws, standards, regulations, directives and other technical provisions take priority over the German/European directives specified in this manual: The information herein is not binding for other countries and regions; as said above, they should be understood as a recommendation.

1.4 Other applicable documents

This instruction for use describes the mounting of an accessory set for an Advantix Vario shower channel in rough steps.



The instructions for use of the Advantix Vario shower channel must also be strictly observed for the mounting of the accessory set.



2 Product information

2.1 Standards and regulations

The following standards and regulations apply to Germany / Europe and are provided as a support feature.

2.2 Certification

Data acc. to DIN EN 1253, Table 7

manufacturer	Viega Holding GmbH & Co.KG
manufacturer identification mark	
Certificate of conformity	
Address	Viega Technology GmbH & Co.KG Viega Platz 1 57439 Attendorn Germany
Relevant standard	DIN EN 1253-2
Load class	K3
Product class with respect to temperature behaviour	A

2.3 Product description

The standing grate set may only be mounted in Viega Advantix Vario shower channels model 4965.10 and 4966.10.

Model	4965.33
Article	711 887
Description	Advantix Vario standing grate

2.3.1 Overview

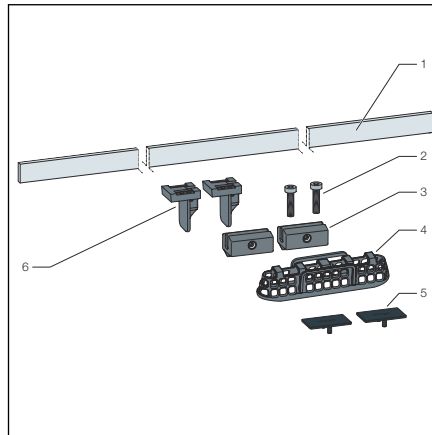

Fig. 1: Scope of delivery

- 1 Standing grate
- 2 Adjusting screws
- 3 Grate support
- 4 Sieve insert
- 5 Cover caps
- 6 Standing grate holder

3 Handling

3.1

3.1.1 Installation dimensions

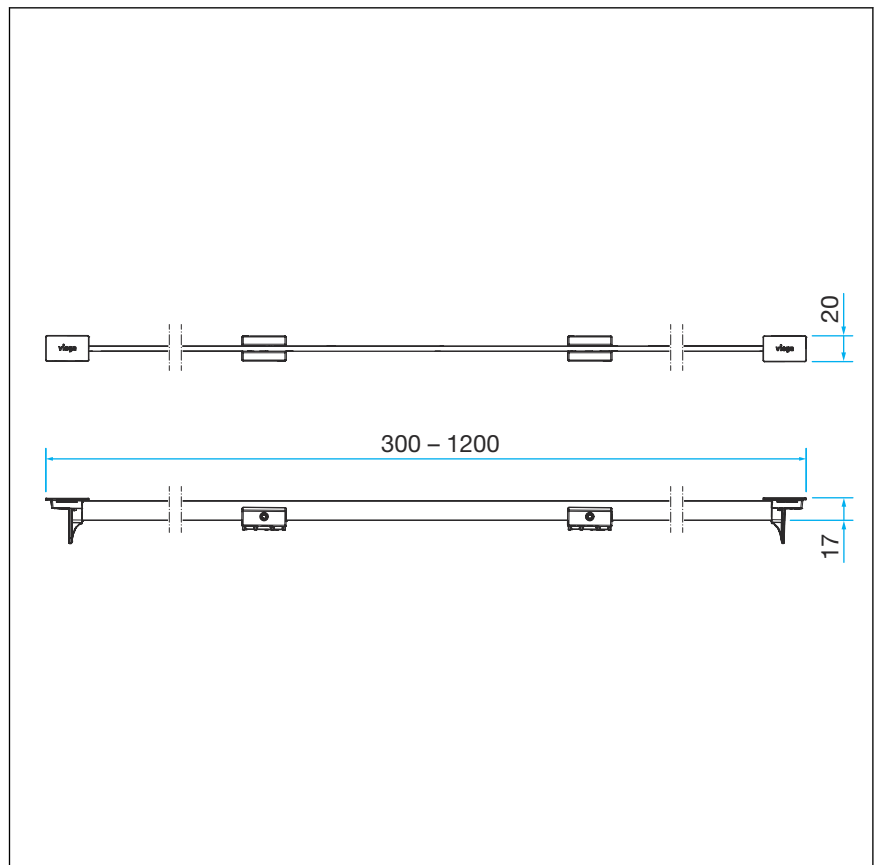
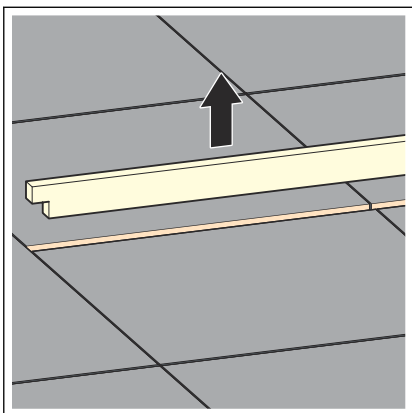
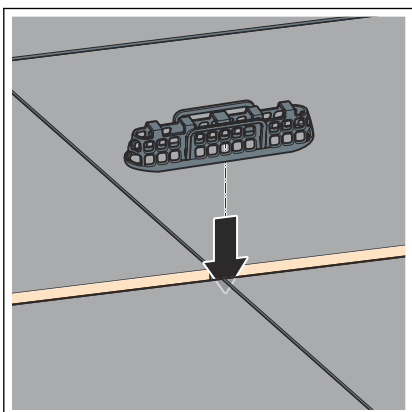

Fig. 2: Installation dimensions

3.2 Assembly



► Remove the site protection.



► Fit the sieve insert.

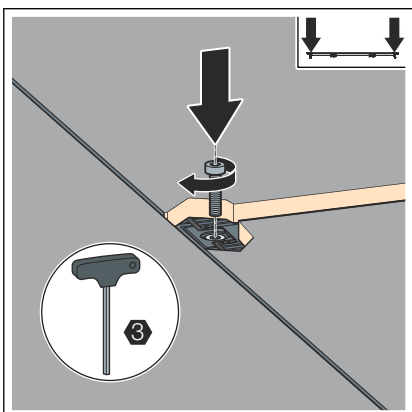

► Insert the adjusting screw.

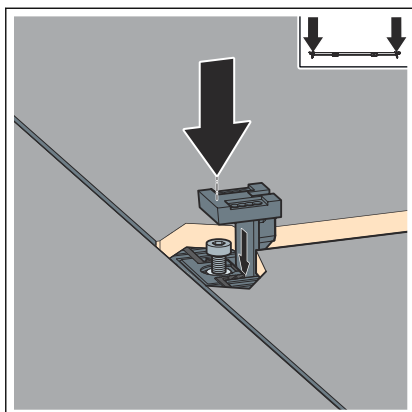

- Place the standing grate holder on the adjusting screw and adjust to tile level.

INFO! The max. standing grate height is 20 mm above the channel flange, using natural stone set (art. no. 686 321) 30 mm.

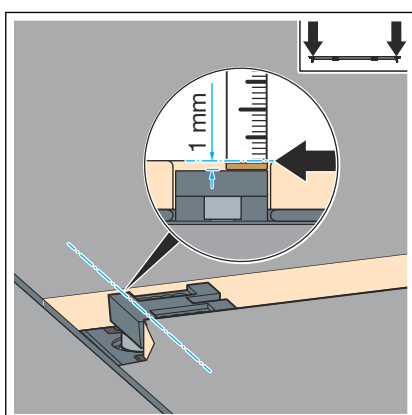

- The upper edge of the standing grate holder must be approx. 1 mm below the upper edge of the tiles.

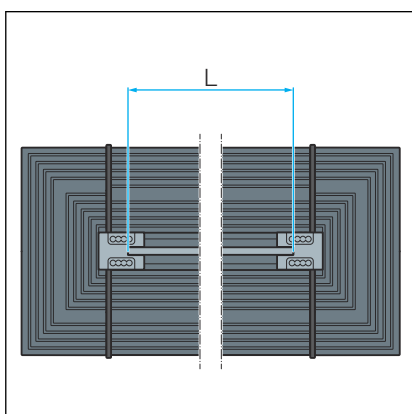

- Determine the standing grate length.

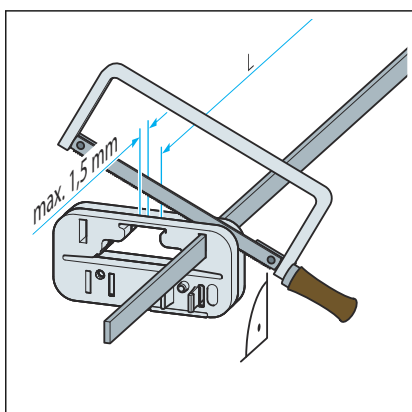

NOTICE! The standing grate must not be shortened with a cutting disc (angle grinder).

- If required, shorten the standing grate with a handsaw and deburr.

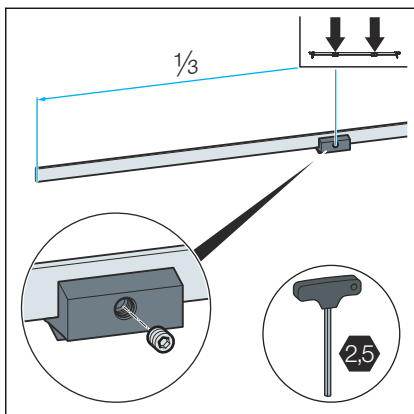

► Fix the grate support at the standing grate.

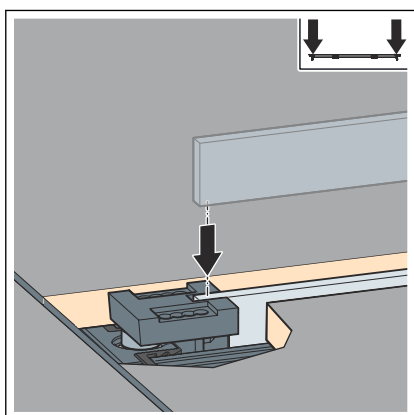

► Insert the standing grate.

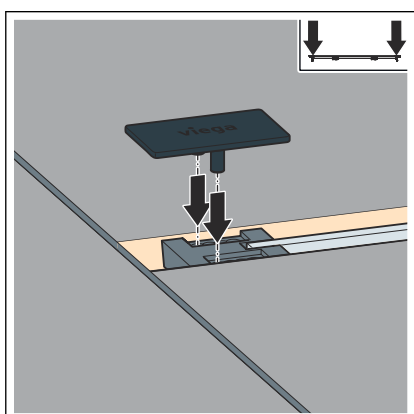

► The cover caps can be moved by up to 9 mm.

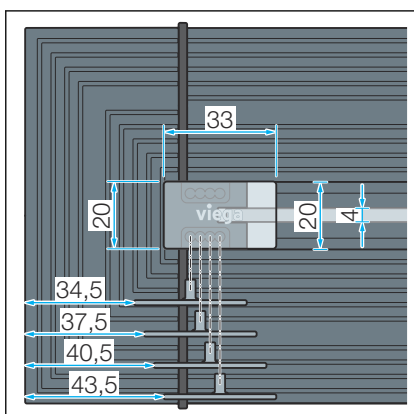

► Adjustability of the cover caps.

3.2.1 Care



NOTICE!
Risk of damage due to unsuitable cleaning agent.

The following cleaning agents can damage chrome-plated surfaces and therefore may not be used:

- Scouring agent
- Abrasive sponges
- Lime, plaster or cement dissolver
- Solvents or other acidic cleaning agents

Normal soap or a mild cleaning agent can be used for regular care and prevention of lime scale. Under no circumstances should scouring agent or scratching objects be used.

Strong stains, even around the drain unit and the siphon, can be removed using typical household cleaner. Please note that the cleaning agent must be rinsed off thoroughly with clear water after the prescribed soaking time. There should be no residue on the components.

3.3 Disposal

Separate the product and packaging materials (e. g. paper, metal, plastic or non-ferrous metals) and dispose of in accordance with valid national legal requirements.



Viega GmbH & Co. KG
service-technik@viega.de
viega.com

INT • 2022-08 • VPN200025

