

Instructions for Use

Simplex drain/overflow, flat version



for standard bathtubs and for bathtubs with
drain hole $\varnothing 52$

Model
6168.46

Year built (from)
07/2019

viega

Table of contents

1	About these instructions for use	3
	1.1 Target groups	3
	1.2 Labelling of notes	3
	1.3 About this translated version	4
2	Product information	5
	2.1 Intended use	5
	2.1.1 Areas of use	5
	2.2 Product description	6
	2.2.1 Overview	6
	2.2.2 Technical data	7
3	Handling	8
	3.1 Assembly information	8
	3.1.1 Mounting conditions	8
	3.1.2 Installation dimensions	8
	3.1.3 Required tools and materials	9
	3.2 Assembly	9
	3.2.1 Mounting overflow	9
	3.2.2 Mounting the drain	9
	3.2.3 Connecting the wastewater system	10
	3.3 Disposal	10

1 About these instructions for use

Trade mark rights exist for this document; for further information, go to viega.com/legal.

1.1 Target groups

The information in this instruction manual is directed at the following groups of people:

- Heating and sanitary professionals and trained personnel
- Operators
- Consumers

Individuals without the abovementioned training or qualification are not permitted to mount, install and, if required, maintain this product. This restriction does not extend to possible operating instructions.

The installation of Viega products must take place in accordance with the general rules of engineering and the Viega instructions for use.

1.2 Labelling of notes

Warning and advisory texts are set aside from the remainder of the text and are labelled with the relevant pictographs.



DANGER!

This symbol warns of possible life-threatening injury.



WARNING!

This symbol warns of possible serious injury.



CAUTION!

This symbol warns of possible injury.



NOTICE!

This symbol warns of possible damage to property.



This symbol gives additional information and hints.

1.3 About this translated version

This instruction for use contains important information about the choice of product or system, assembly and commissioning as well as intended use and, if required, maintenance measures. The information about the products, their properties and application technology are based on the current standards in Europe (e.g. EN) and/or in Germany (e.g. DIN/DVGW).

Some passages in the text may refer to technical codes in Europe/Germany. These should serve as recommendations in the absence of corresponding national regulations. The relevant national laws, standards, regulations, directives and other technical provisions take priority over the German/European directives specified in this manual: The information herein is not binding for other countries and regions; as said above, they should be understood as a recommendation.

2 Product information

2.1 Intended use

2.1.1 Areas of use



NOTICE!

Risk of damage due to unsuitable liquids

To avoid damaging the drain, only introduce the following liquids:

- Typical household wastewater with temperatures up to 95 °C
- The pH value must be higher than 4 but lower than 10.

The Simplex drain/overflow is a combined drain and overflow with odour trap for bathtubs with a 52 mm drain hole.

The drain/overflow is suitable for standard bathtubs with the drain on the head end.

2.2 Product description

2.2.1 Overview

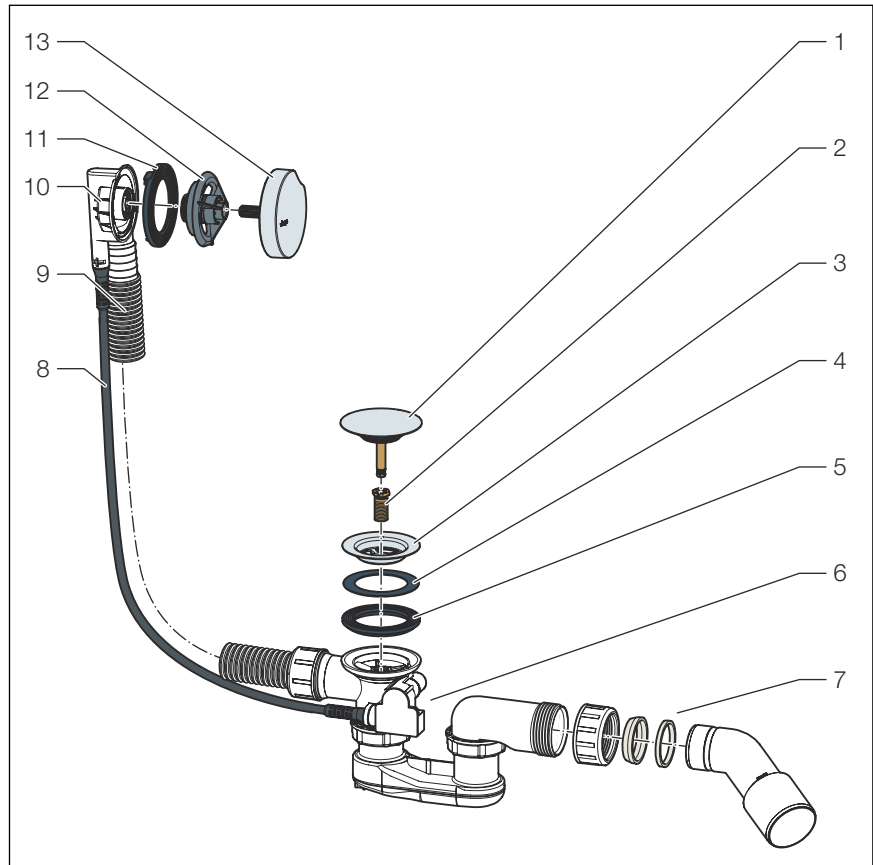

Fig. 1: Component overview

- 1 valve cone
- 2 fixing screw
- 3 valve top
- 4 Sealing
- 5 Sealing
- 6 drain unit with odour trap
- 7 Union nut with seal
- 8 Bowden cable
- 9 Flexible overflow pipe
- 10 overflow unit
- 11 profile seal
- 12 fixing flange
- 13 rotatable rosette

2.2.2 Technical data

Drainage capacity (at an accumulation height of 300 mm)	0.92 l/s
Overflow capacity (at an accumulation height of 60 mm)	0.63 l/s
Diameter of bathtub drain hole	52 mm
Length of Bowden cable	725 mm
Length / height	755 mm
Dimensions and installation depth	↳ Chapter 3.1.2 'Installation dimensions' on page 8
Water seal level	50 mm

3 Handling

3.1 Assembly information

3.1.1 Mounting conditions

The following requirements exist for the mounting of the drain / overflow:

- The bathtub is installed.
- The drainage line is installed all the way to the bathtub.
- The underside of the bathtub is accessible.

3.1.2 Installation dimensions

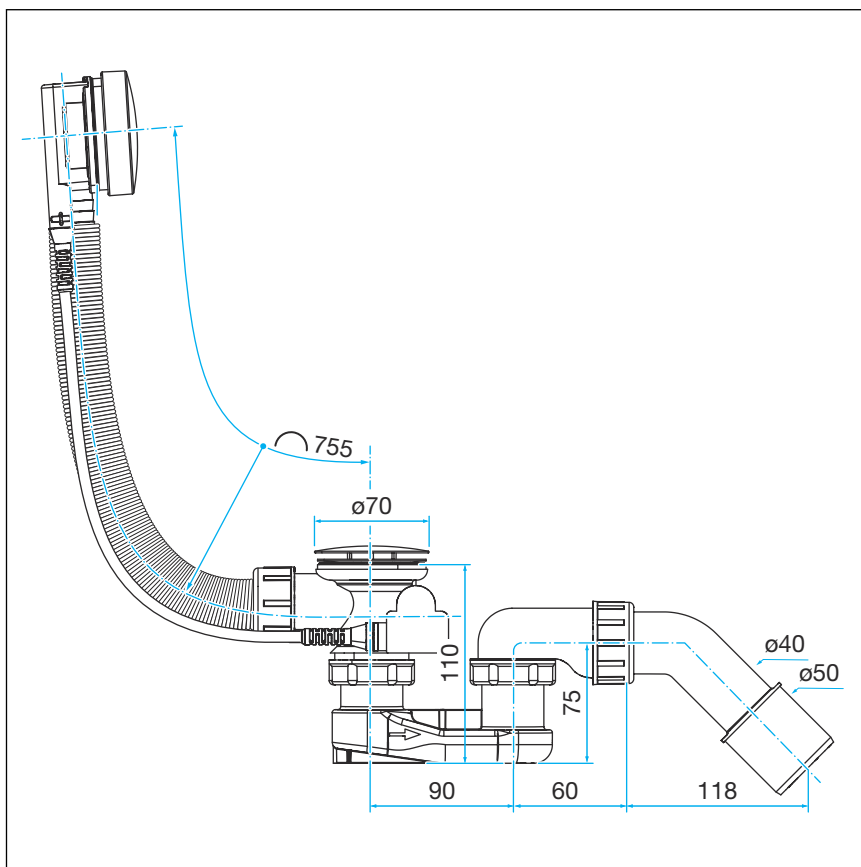

Fig. 2: Dimensional drawing

3.1.3 Required tools and materials

Tool

The following tools are required for mounting:

- socket spanner (size 14)
- fine-toothed saw
- flat-blade screwdriver

Material

No additional material is required for the complete mounting of the product.

3.2 Assembly

3.2.1 Mounting overflow

Proceed as follows to the mounting of the overflow:

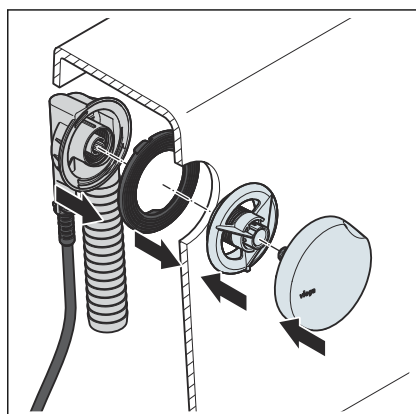

- Fit the profile seal in the overflow unit.
- Hold the overflow unit on the overflow opening of the bathtub from the outside.
- Screw the fixing flange into the overflow unit by hand.
Align and fit the rotatable rosette.

NOTICE! Only turn the fixing flange by hand. Pliers or other tools may damage the fixing flange.

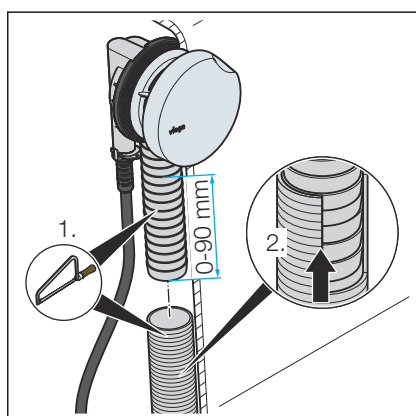

- Shorten the overflow pipe and also the connection pipe on the overflow unit if required.
- Push the overflow pipe onto the overflow unit.

3.2.2 Mounting the drain

Proceed as follows to mount the drain:

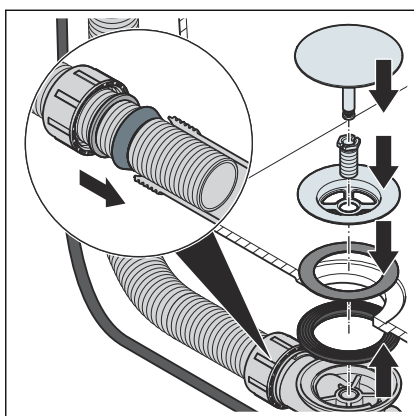

- Place the profile seal in the recess of the drain unit.
- Mount the drain unit with profile seal on the drain hole of the bathtub from below.
- Insert the second seal above the bottom of the bath tub.
- Fit the valve top in the drain hole.
- Place the fixing screw in the drain unit and tighten with a socket spanner (size 14) or a Viega mounting aid.
- Push the union nut, sliding ring and seal onto the bottom end of the overflow pipe.
- Place the overflow pipe in the drain unit and screw together.

Maintain the insertion depth of at least 15 mm.

3.2.3 Connecting the wastewater system

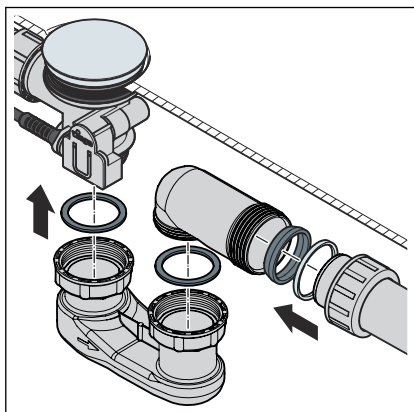

- Mount the odour trap with the seals on the drain unit and the connection elbow. Tighten the union nuts by hand.
Observe the flow direction (see arrow on odour trap).
- Push the union nut, sliding ring and sealing onto the drainpipe.
- The seal must sit securely in the recess.
- Screw the union nut on the drain unit.
- Connect the drain to the drainage system.

3.3 Disposal

Separate the product and packaging materials (e. g. paper, metal, plastic or non-ferrous metals) and dispose of in accordance with valid national legal requirements.



Viega GmbH & Co. KG
service-technik@viega.de
viega.com

INT • 2022-08 • VPN190429

