

Instructions for Use

Prevista Dry Plus fitting holder for concealed fitting

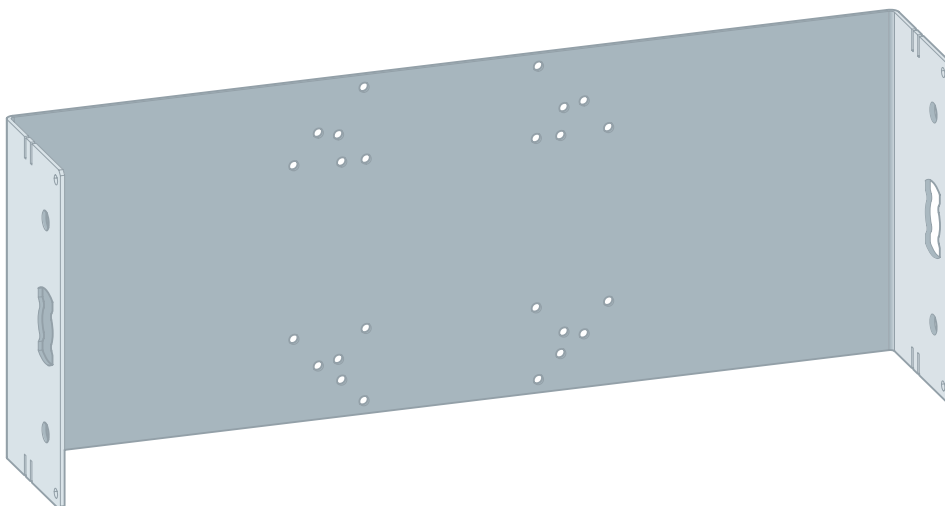

For concealed fitting

Model
8555.34

Year built (from)
12/2018

viega

Table of contents

1	About these instructions for use	3
	1.1 Target groups	3
	1.2 Labelling of notes	3
	1.3 About this translated version	4
2	Product information	5
	2.1 Standards and regulations	5
	2.2 Intended use	5
	2.2.1 Areas of use	5
	2.3 Product description	6
	2.3.1 Overview	6
	2.3.2 Compatible components	6
3	Handling	7
	3.1 Assembly information	7
	3.1.1 Installation dimensions	7
	3.2 Assembly	8
	3.2.1 Mounting module	8
	3.2.2 Rounding off jobs	13
	3.3 Disposal	13

1 About these instructions for use

Trade mark rights exist for this document; for further information, go to viega.com/legal.

1.1 Target groups

The information in this instruction manual is directed at the following groups of people:

- Heating and sanitary professionals and trained personnel
- Consumers

Individuals without the abovementioned training or qualification are not permitted to mount, install and, if required, maintain this product. This restriction does not extend to possible operating instructions.

The installation of Viega products must take place in accordance with the general rules of engineering and the Viega instructions for use.

1.2 Labelling of notes

Warning and advisory texts are set aside from the remainder of the text and are labelled with the relevant pictographs.



DANGER!

This symbol warns of possible life-threatening injury.



WARNING!

This symbol warns of possible serious injury.



CAUTION!

This symbol warns of possible injury.



NOTICE!

This symbol warns of possible damage to property.



This symbol gives additional information and hints.

1.3 About this translated version

This instruction for use contains important information about the choice of product or system, assembly and commissioning as well as intended use and, if required, maintenance measures. The information about the products, their properties and application technology are based on the current standards in Europe (e.g. EN) and/or in Germany (e.g. DIN/DVGW).

Some passages in the text may refer to technical codes in Europe/Germany. These should serve as recommendations in the absence of corresponding national regulations. The relevant national laws, standards, regulations, directives and other technical provisions take priority over the German/European directives specified in this manual: The information herein is not binding for other countries and regions; as said above, they should be understood as a recommendation.

2 Product information

2.1 Standards and regulations

The following standards and regulations apply to Germany / Europe and are provided as a support feature.

Regulations from section: Fields of application / Mounting conditions

Scope / Notice	Regulations applicable in Germany
Suitable masonry walls	EN 1996-1-1
Suitable concreted walls	DIN 1045

2.2 Intended use

2.2.1 Areas of use

The fitting holder is suitable for mounting on wall constructions pursuant to the regulations in section [↗](#) 'Regulations from section: Fields of application / Mounting conditions' on page 5 and is intended for use in a Prevista Dry Plus pre-wall construction.

2.3 Product description

2.3.1 Overview

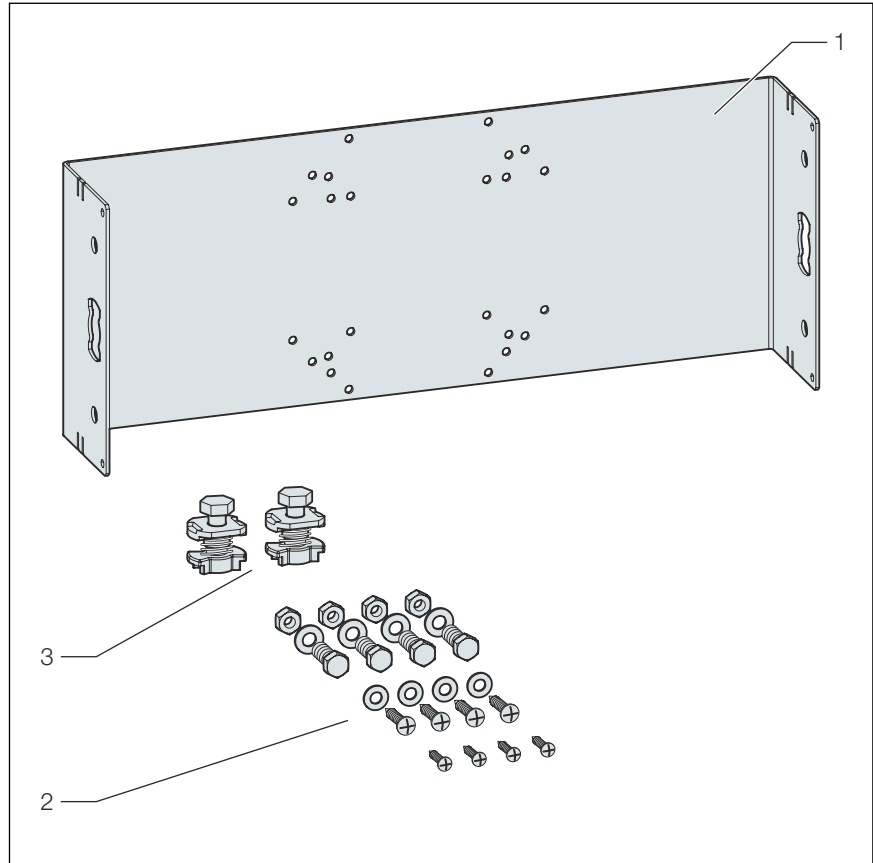

Fig. 1: Scope of delivery

- 1 Fitting holders
- 2 Screws for fixing in support profile
- 3 slot nuts

2.3.2 Compatible components

The fitting holder is intended for use with a concealed fitting.

3 Handling

3.1 Assembly information

3.1.1 Installation dimensions

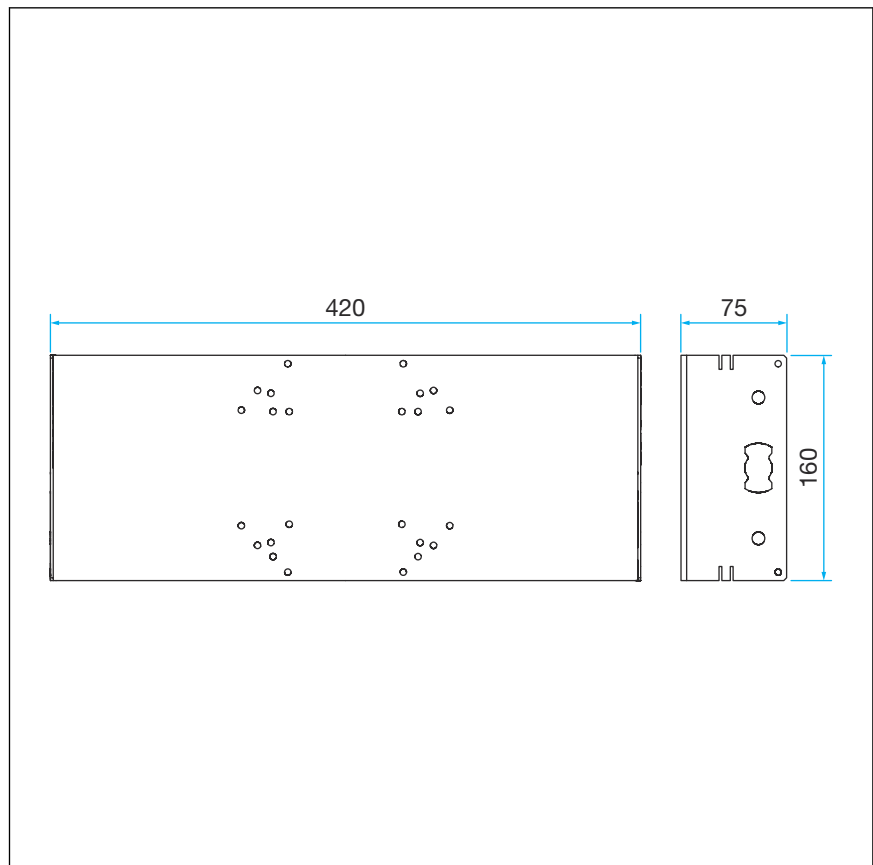
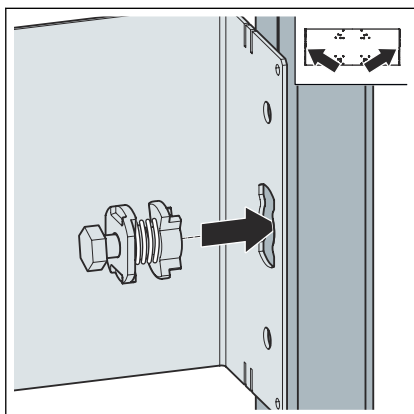

Fig. 2: Installation dimensions

3.2 Assembly

3.2.1 Mounting module

Securing module



- Use the slot nuts supplied to attach the fitting holder to the open mounting rail.

Insert the slot nut into the opening of the module.

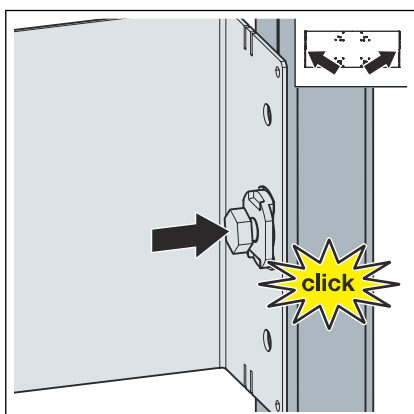

- Push the slot nut in until it engages.

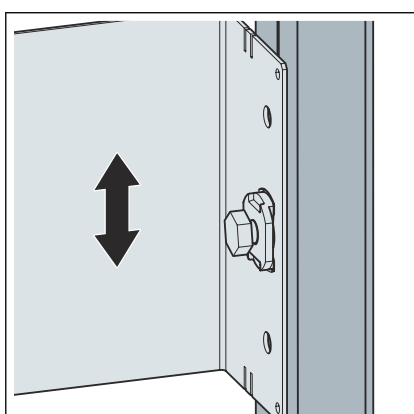

- Set the height of the rail.

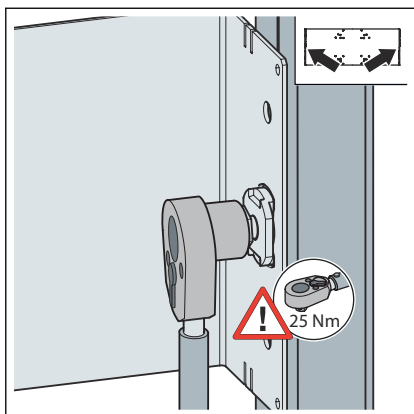

► Fasten the slot nut.

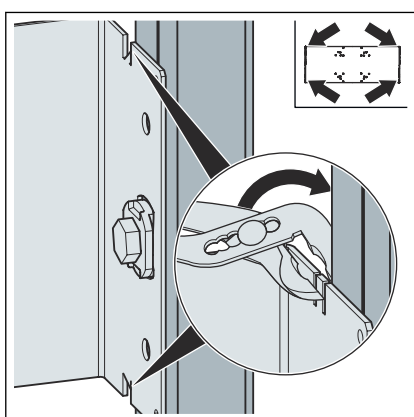

► Bend the sides of the metal bars of the fitting holder.

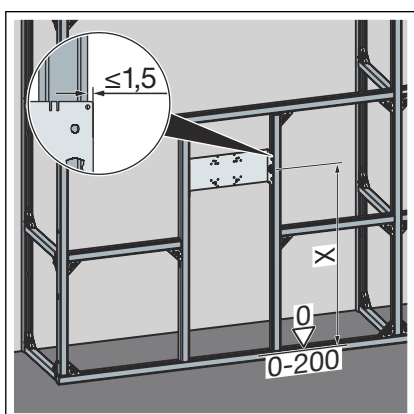

► Set the height of the fitting holder according to the information of the sanitary item manufacturer.

Hole sizes

The fitting holder is suitable for the following concealed fittings:

- Grohe "Rapido E"
- Hansa "HANSAVAROX"
- Hansgrohe "I-Box"

- Ideal Standard "EASY-Box"
- Keuco "Flexx Boxx"

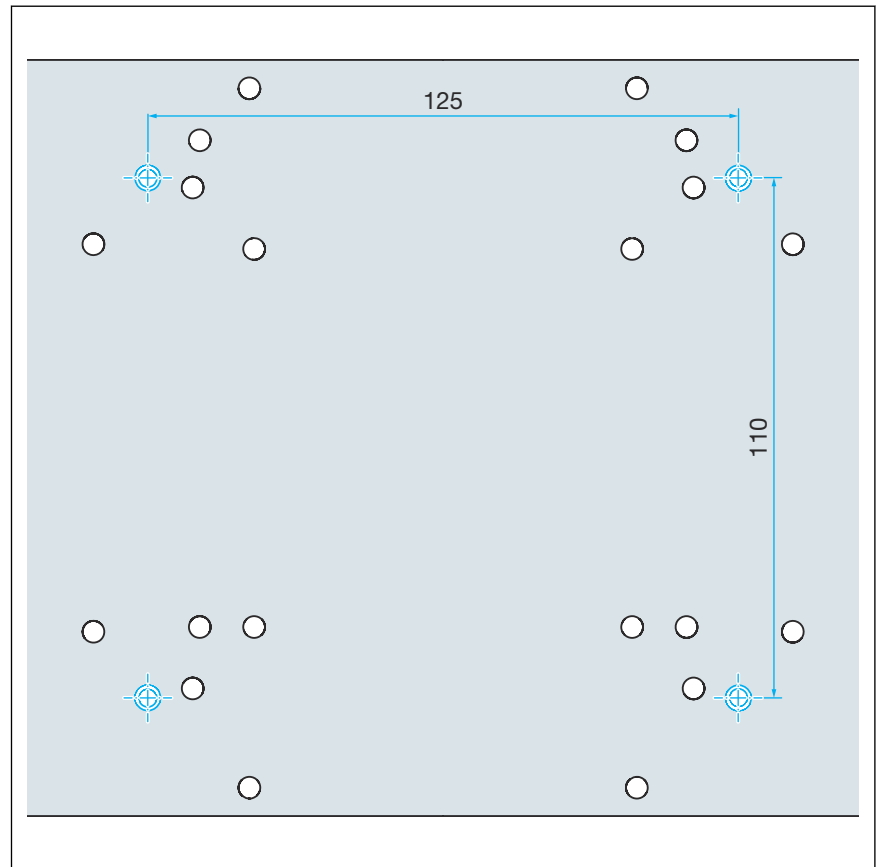

Fig. 3: Grohe "Rapido E"

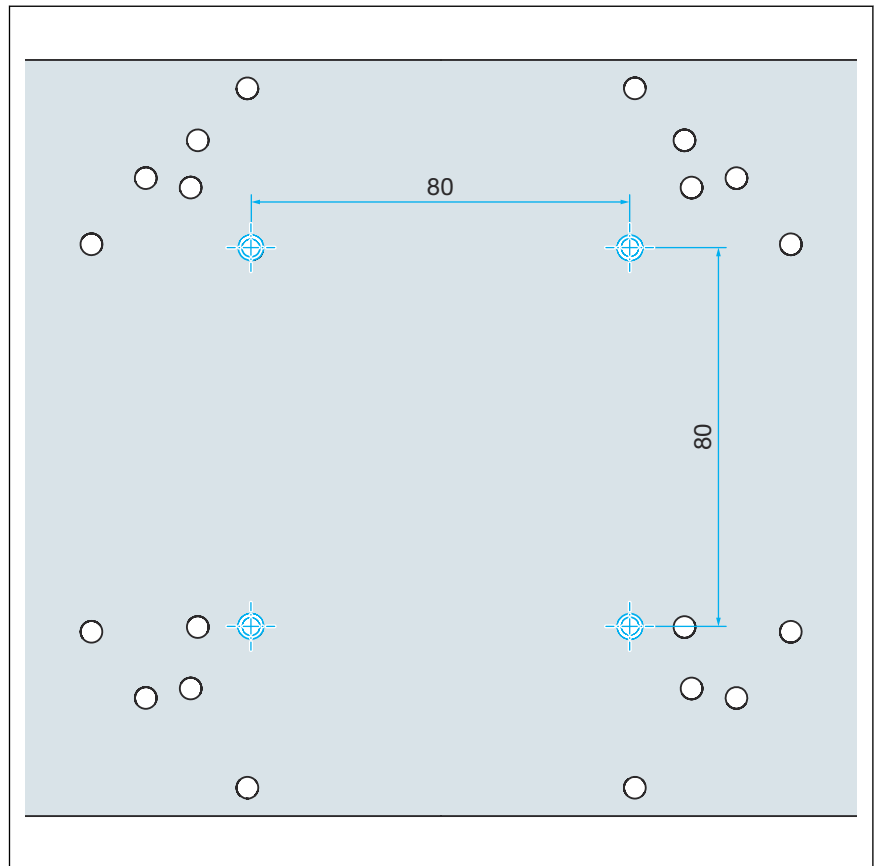

Fig. 4: Hansa HANSAVAROX

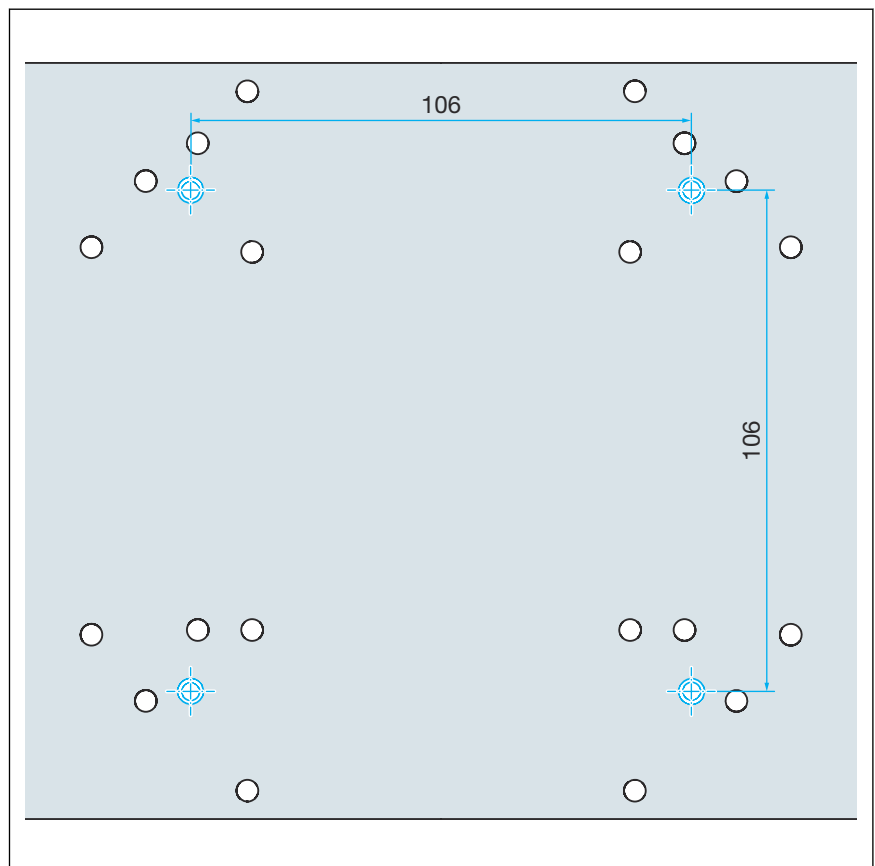

Fig. 5: Hansgrohe "I-Box"

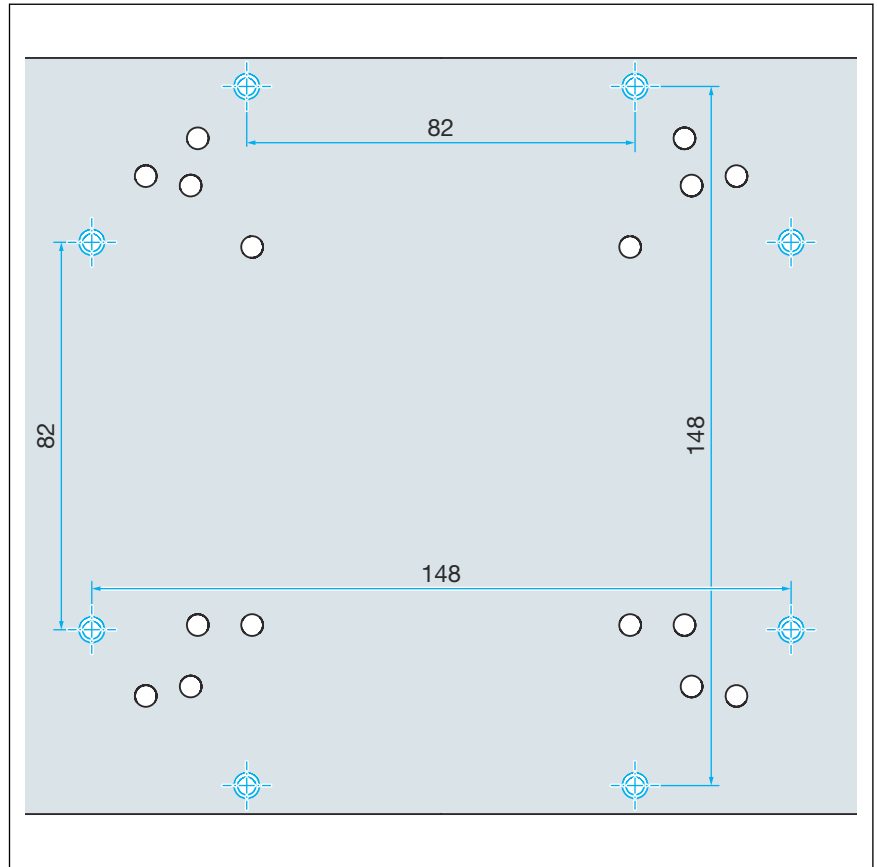

Fig. 6: Ideal Standard "EASY-Box"

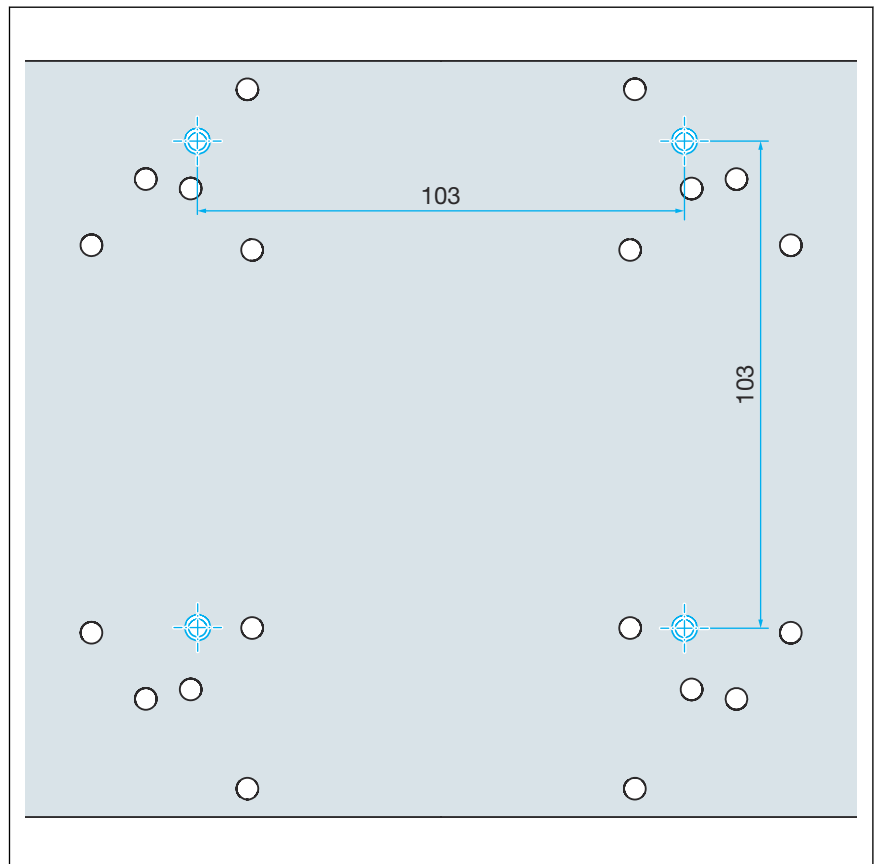
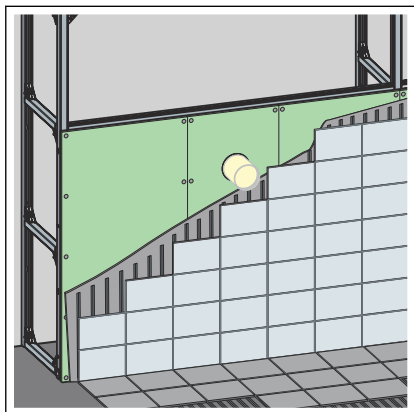

Fig. 7: Keuco "Flexx Boxx"

3.2.2 Rounding off jobs



- Clad the pre-wall with suitable gypsum cardboard cladding panels. Make sure that no abutting edges converge.
- Grout the abutting edges and joints with a suitable filler.
- For more detailed information, observe the mounting instructions for the gypsum cardboard cladding panels.

3.3 Disposal

Separate the product and packaging materials (e. g. paper, metal, plastic or non-ferrous metals) and dispose of in accordance with valid national legal requirements.



Viega GmbH & Co. KG
service-technik@viega.de
viega.com

INT • 2022-08 • VPN180633

