

Instructions for Use

Odour trap

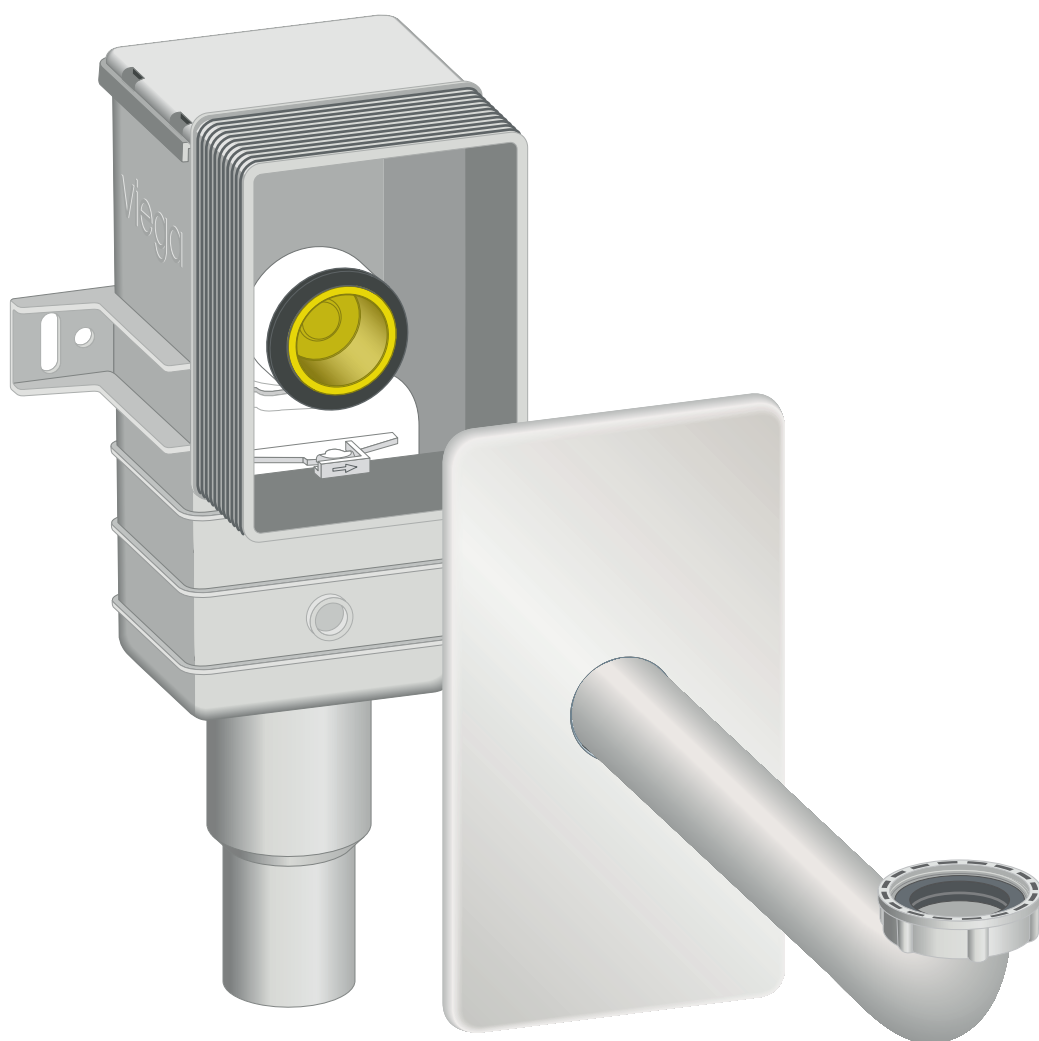

For concealed mounting

Model
5633.2

Year built (from)
05/2005

viega

Table of contents

1	About these instructions for use	3
	1.1 Target groups	3
	1.2 Labelling of notes	3
	1.3 About this translated version	4
2	Product information	5
	2.1 Intended use	5
	2.1.1 Areas of application	5
	2.2 Product description	6
	2.2.1 Overview	6
	2.2.2 Technical data	6
3	Handling	7
	3.1 Assembly information	7
	3.1.1 Installation dimensions	7
	3.2 Assembly	8
	3.2.1 Mounting the odour trap	8
	3.2.2 Replacing the odour trap	11
	3.3 Care	12
	3.4 Disposal	12

1 About these instructions for use

Trade mark rights exist for this document; for further information, go to viega.com/legal.

1.1 Target groups

The information in this instruction manual is directed at the following groups of people:

- Heating and plumbing experts and trained personnel
- Consumers

Individuals without the abovementioned training or qualification are not permitted to mount, install and, if required, maintain this product. This restriction does not extend to possible operating instructions.

The installation of Viega products must take place in accordance with the general rules of engineering and the Viega instructions for use.

1.2 Labelling of notes

Warning and advisory texts are set aside from the remainder of the text and are labelled with the relevant pictographs.



DANGER!

This symbol warns of possible life-threatening injury.



WARNING!

This symbol warns of possible serious injury.



CAUTION!

This symbol warns of possible injury.



NOTICE!

This symbol warns of possible damage to property.



This symbol gives additional information and hints.

1.3 About this translated version

This instruction for use contains important information about the choice of product or system, assembly and commissioning as well as intended use and, if required, maintenance measures. The information about the products, their properties and application technology are based on the current standards in Europe (e.g. EN) and/or in Germany (e.g. DIN/DVGW).

Some passages in the text may refer to technical codes in Europe/Germany. These should serve as recommendations in the absence of corresponding national regulations. The relevant national laws, standards, regulations, directives and other technical provisions take priority over the German/European directives specified in this manual: The information herein is not binding for other countries and regions; as said above, they should be understood as a recommendation.

2 Product information

2.1 Intended use

2.1.1 Areas of application

**NOTICE!****Risk of damage due to unsuitable liquids**

To avoid damaging the drain, only introduce the following liquids:

- Typical household wastewater with temperatures up to 95 °C
- The pH value must be higher than 4 but lower than 10.

The odour trap is for washbasins with 1¼ inch connection.

2.2 Product description

2.2.1 Overview

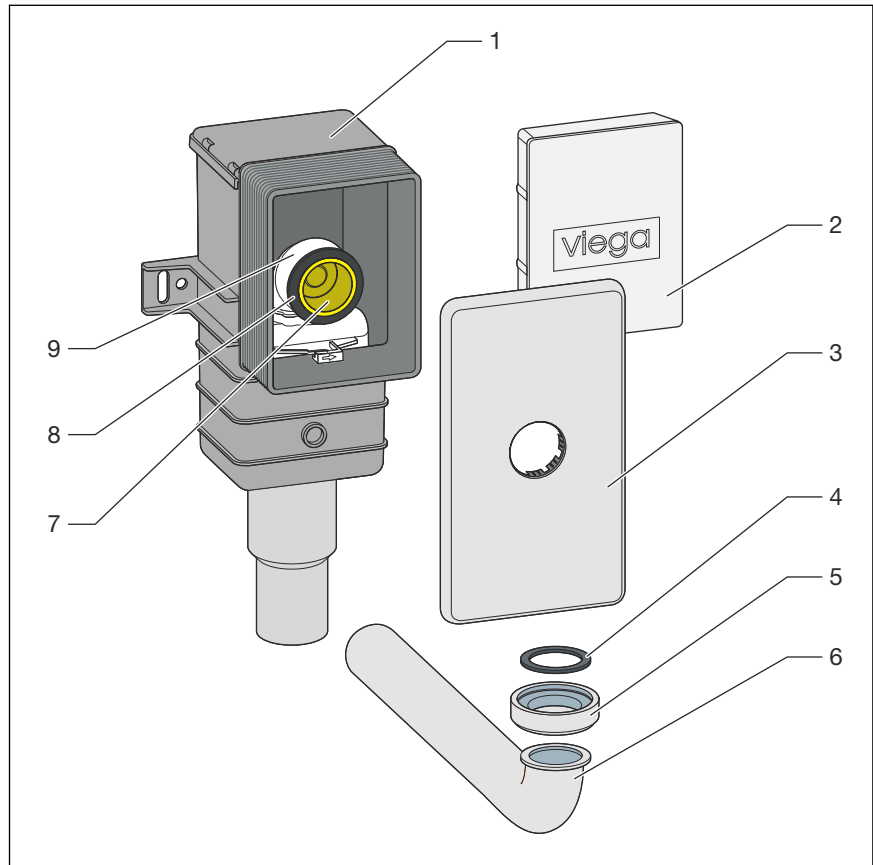

Fig. 1: Overview

- 1 Concealed connection box
- 2 Site protection
- 3 Cover plate
- 4 Seal
- 5 Union nut
- 6 Drain elbow 90°
- 7 Site protection
- 8 Lip seal
- 9 Odour trap

2.2.2 Technical data

DN (nominal width) outlet pipe	DN 32 mm
Drain elbow connection	1¼
Water seal level	50 mm

3 Handling

3.1 Assembly information

3.1.1 Installation dimensions

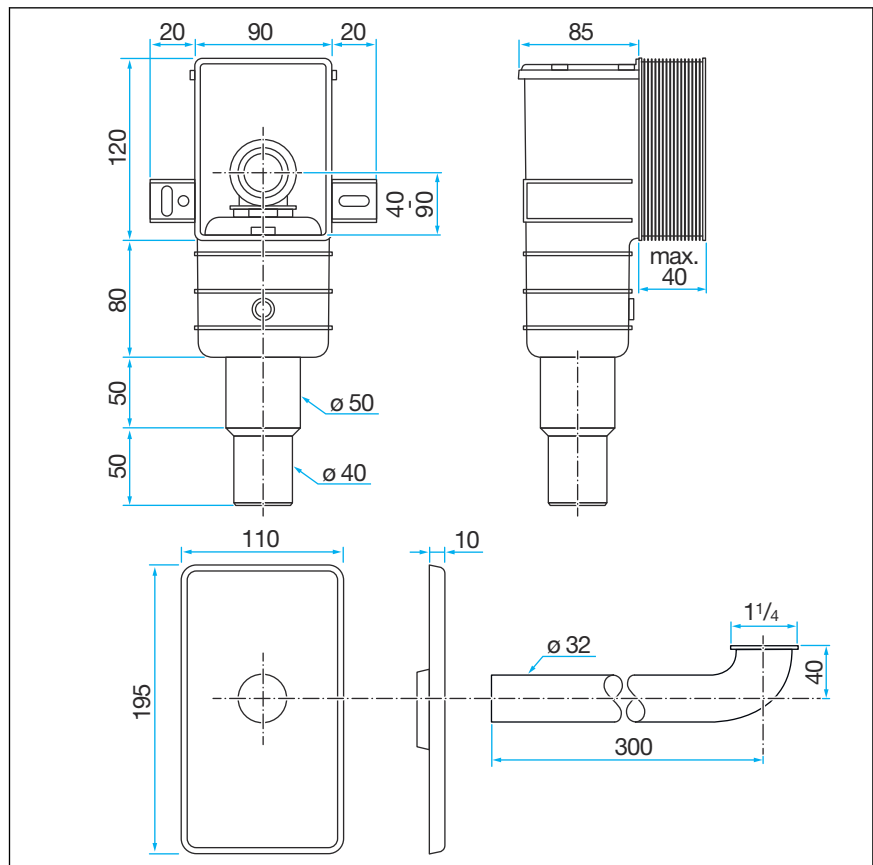

Fig. 2: Dimensional drawing

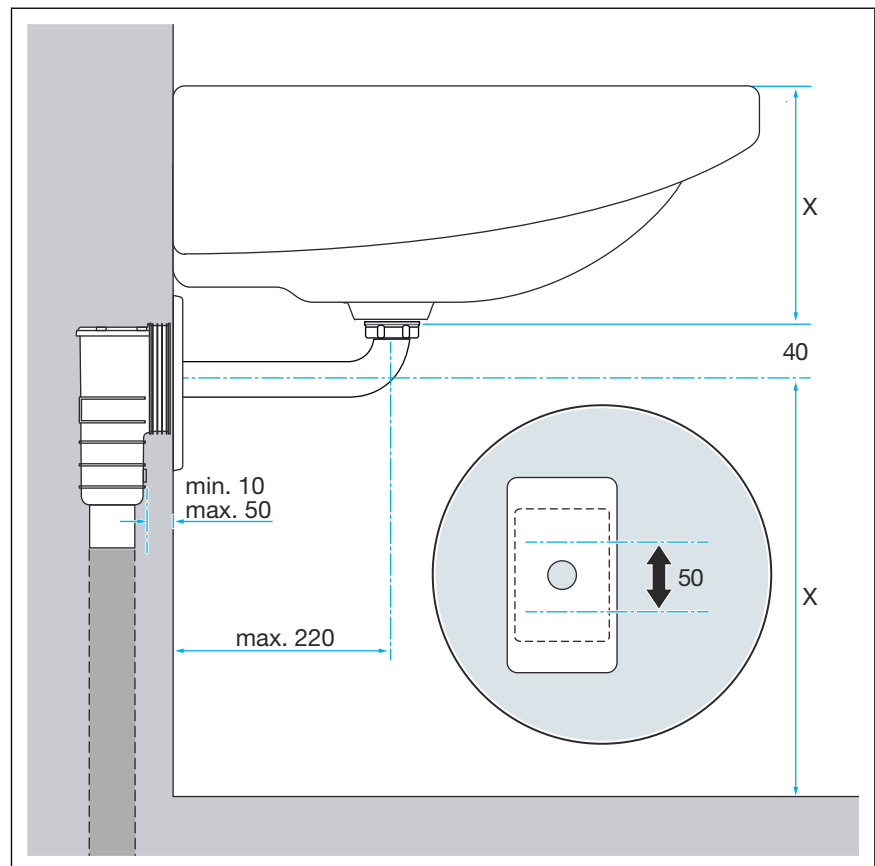

Fig. 3: Installation dimensions

3.2 Assembly

3.2.1 Mounting the odour trap

Requirements:

- The drain pipeline is installed.
- Remove the site protection.

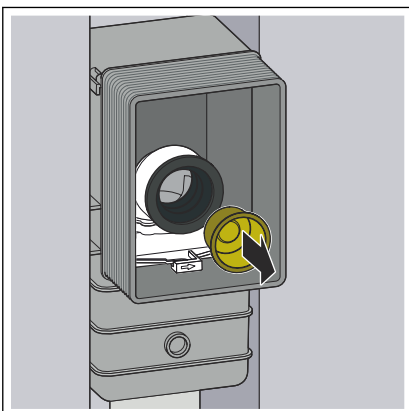

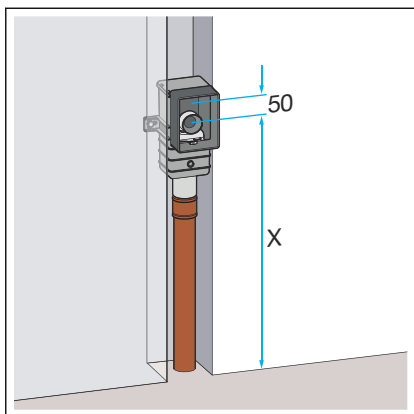

► Variable height adjustment of the odour trap of 50 mm.

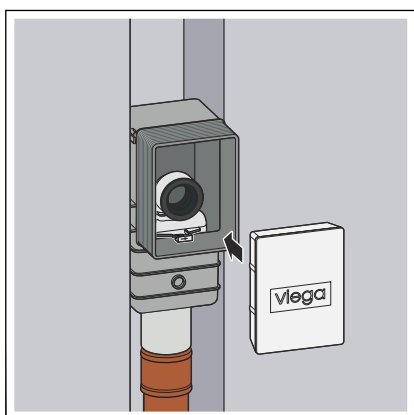

► Put on the shaft cover.

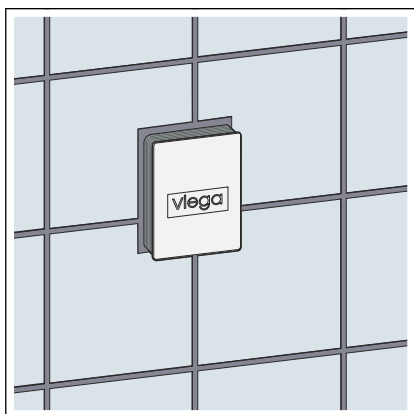

► Tile the wall.

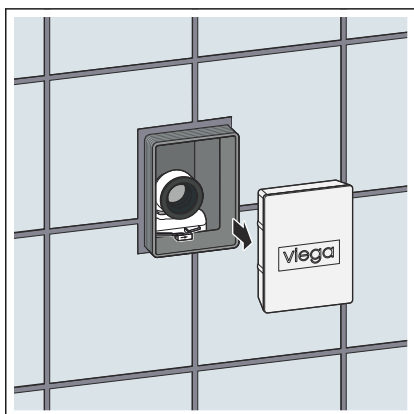

► Remove the shaft cover.

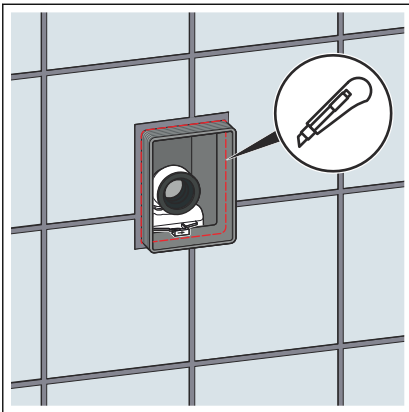

- Shorten the sides of the inspection shaft up to the tile level.

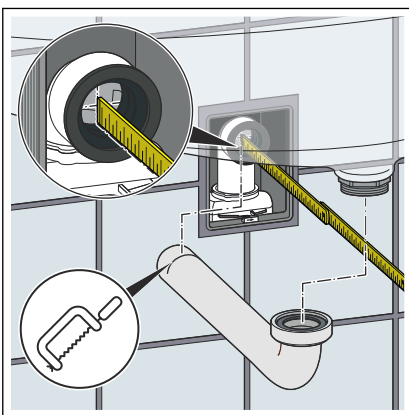

- Determine the dimension between the end of the lip seal and the lower edge of the washbasin (UKWT).
- Adjust the drainpipe.

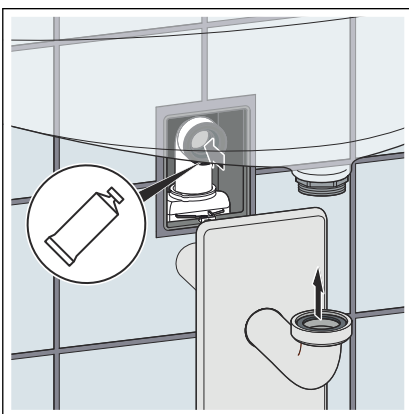

- Coat the lip seal with the lubricant.
- Slide the cover plate over the waste elbow.
- Connect the waste elbow to the washbasin.

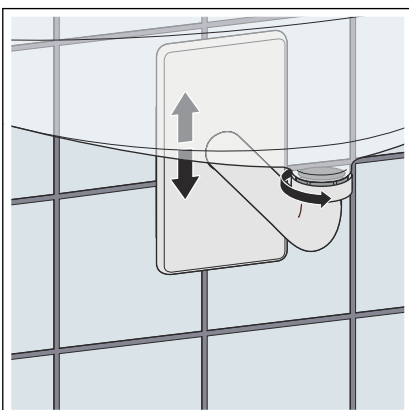

- Connect the waste elbow to the odour trap insert.
- Adjust the height of the cover plate.

3.2.2 Replacing the odour trap

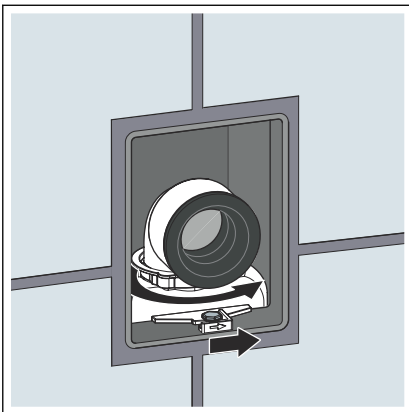

► Release the odour trap insert.

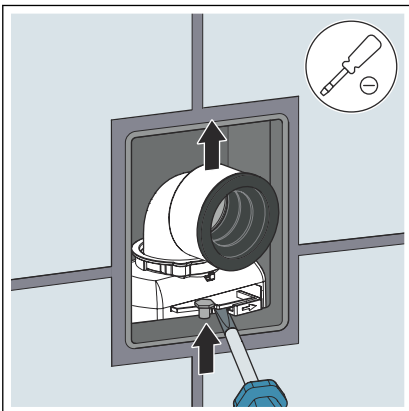

► Lever the odour trap insert upwards.

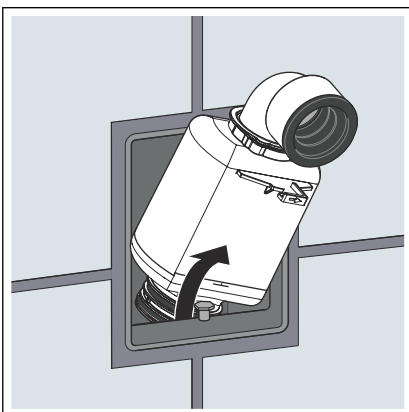

► Remove the odour trap insert.

3.3 Care



NOTICE!

Risk of damage due to unsuitable cleaning agent.

The following cleaning agents can damage chrome-plated surfaces and therefore may not be used:

- Scouring agent
- Abrasive sponges
- Lime, plaster or cement dissolver
- Solvents or other acidic cleaning agents

Use household cleaner to remove coarse soiling, also around the odour trap. Rinse the detergent thoroughly with clear water after the prescribed exposure time. There should be no residue on the components.

3.4 Disposal

Separate the product and packaging materials (e. g. paper, metal, plastic or non-ferrous metals) and dispose of in accordance with valid national legal requirements.



Viega GmbH & Co. KG
service-technik@viega.de
viega.com

INT • 2022-08 • VPN210512

