

Instructions for Use

Connection cable

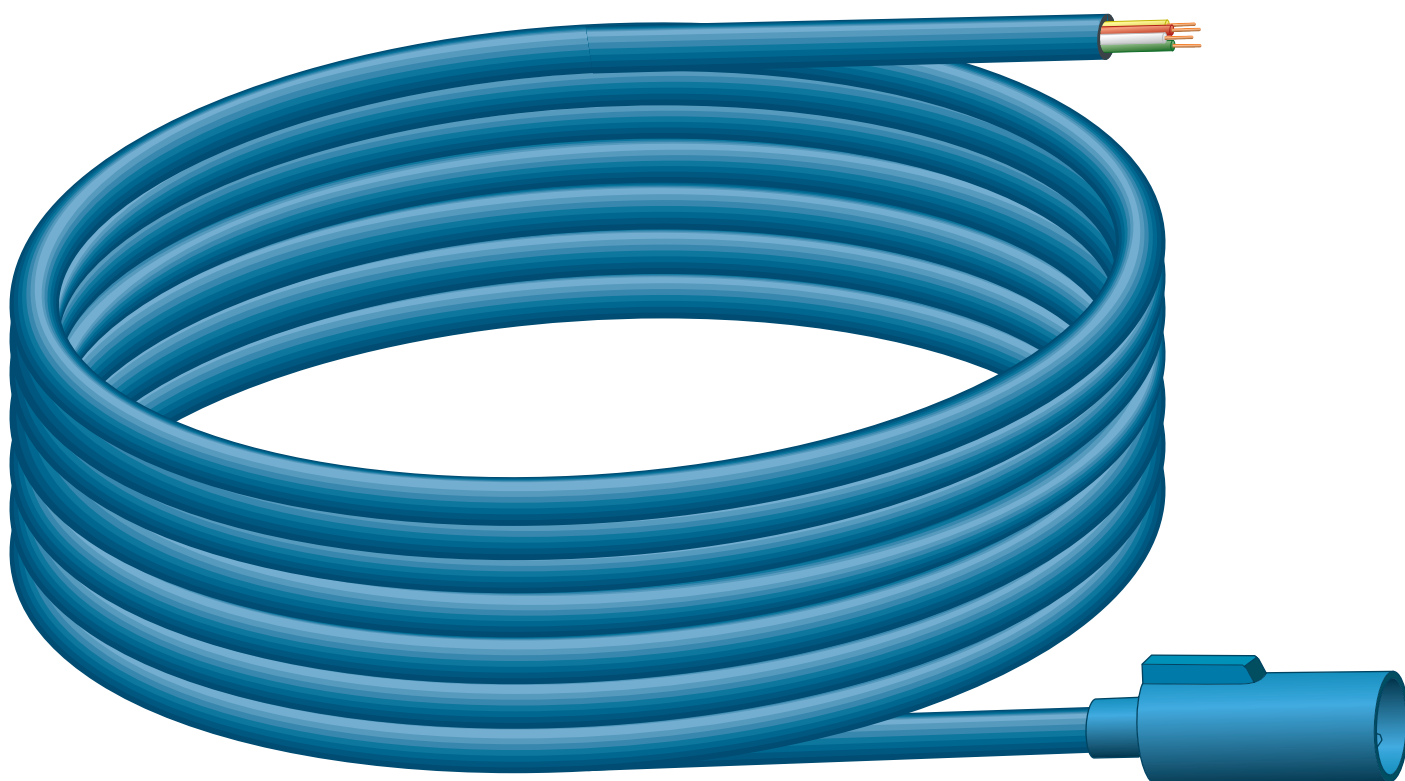

For external flush actuation via on-site and commercially available push-buttons with closing function or potential-free contact (min. closing time 350 ms)

Model
8570.55

Year built (from)
07/2019

viega

Table of contents

1	About these instructions for use	3
	1.1 Target groups	3
	1.2 Labelling of notes	3
	1.3 About this translated version	4
2	Product information	5
	2.1 Intended use	5
	2.1.1 Areas of application	5
	2.2 General notes	5
	2.3 Product description	7
	2.3.1 Overview	7
3	Handling	8
	3.1 Assembly	8
	3.2 Disposal	9

1 About these instructions for use

Trade mark rights exist for this document; for further information, go to viega.com/legal.

1.1 Target groups

The information in this instruction manual is directed at the following groups of people:

- Heating and plumbing experts and trained personnel

Individuals without the above-mentioned training or qualifications are not permitted to mount, install or, if appropriate, maintain this product. This restriction does not extend to possible operating instructions.

The installation of Viega products must take place in accordance with the generally accepted rules of engineering and the Viega instructions for use.

1.2 Labelling of notes

Warning and advisory texts are set aside from the remainder of the text and are labelled with the relevant pictographs.



DANGER!

This symbol warns of possible life-threatening injury.



WARNING!

This symbol warns of possible serious injury.



CAUTION!

This symbol warns of possible injury.



NOTICE!

This symbol warns of possible damage to property.



This symbol gives additional information and hints.

1.3 About this translated version

This instruction for use contains important information about the choice of product or system, assembly and commissioning as well as intended use and, if required, maintenance measures. The information about the products, their properties and application technology are based on the current standards in Europe (e.g. EN) and/or in Germany (e.g. DIN/DVGW).

Some passages in the text may refer to technical codes in Europe/Germany. These should serve as recommendations in the absence of corresponding national regulations. The relevant national laws, standards, regulations, directives and other technical provisions take priority over the German/European directives specified in this manual: The information herein is not binding for other countries and regions; as said above, they should be understood as a recommendation.

2 Product information

2.1 Intended use

2.1.1 Areas of application



The connection cable connects the control to an on-site and commercially available push-button. The connection cable can be used with all electronic Prevista WC actuator plates and WC remote flush actuators.

2.2 General notes

- If you notice any damage on the product or individual components, do not carry out a repair. Instead, have the product replaced by qualified personnel.
- This product is not intended for use by persons (including children) with restricted physical, sensory or mental aptitude or lack of experience and/or knowledge.
- Make sure that children do not play with this product.

Symbols

Observe the symbol listed on the label:

Symbol	Description
	CE marking, Product Safety in Europe
	EAC marking, registration of products in the territory of the Customs Union

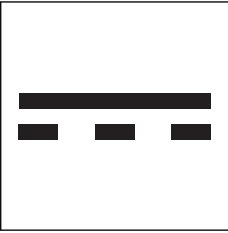
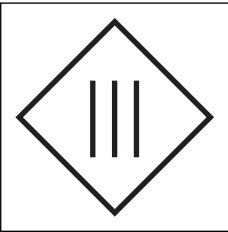
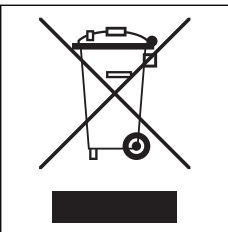
Symbol	Description
	Direct current
	Protection class III
	The marked product must not be disposed of as household waste.

2.3 Product description

2.3.1 Overview

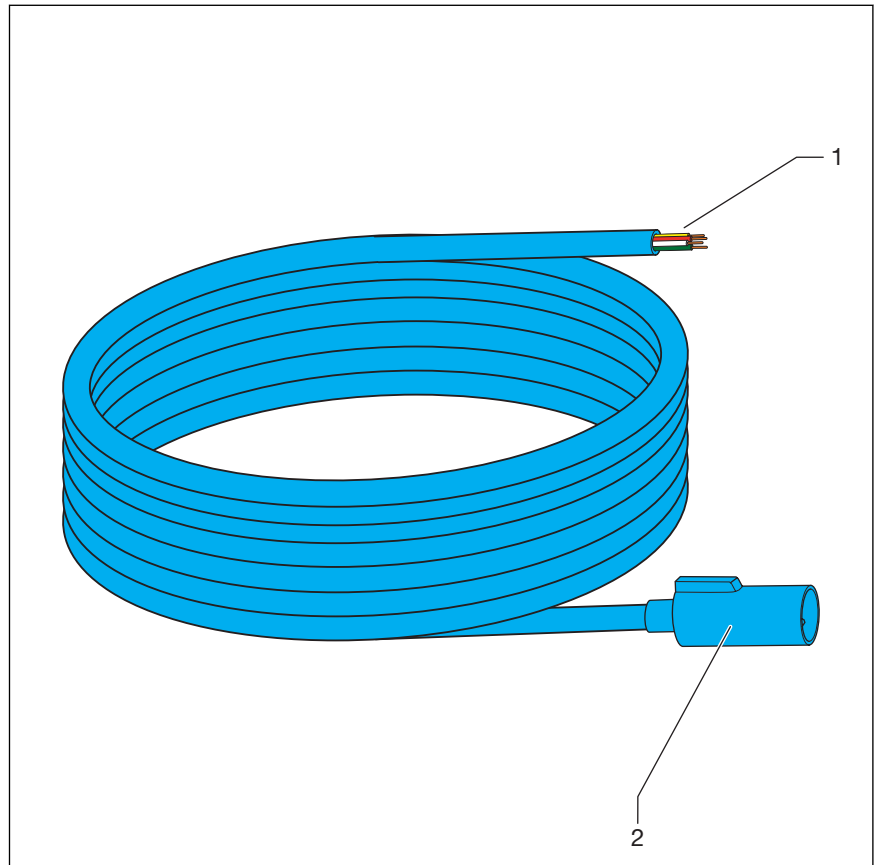

Fig. 1: Connection cable

- 1 Connection cable
- 2 Connection plug

3 Handling

3.1 Assembly

Connecting connection cable

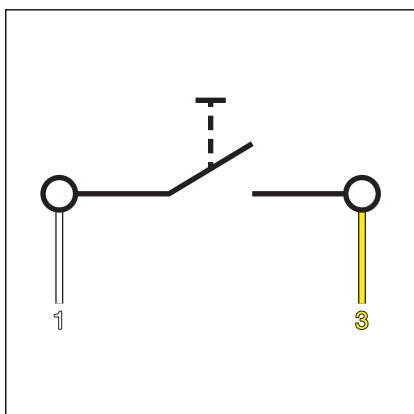

- Connect the NO between the green (1) and the yellow cable (3) to actuate the small flush volume.

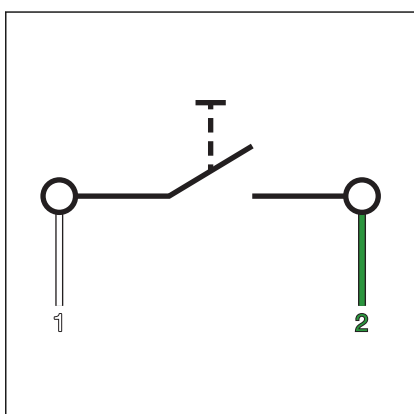

- Connect the contact to actuate the large flush volume between the green (1) and white cable (2).
- Strip the end of the brown cable (e.g., with a lustre terminal).

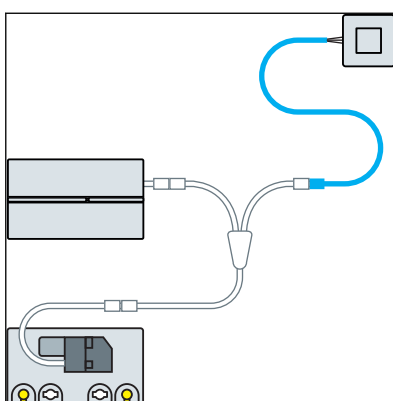

- Attach the connection cable to the control using the extension cable adapter (model 8580.49).

3.2 Disposal

Separate the product and packaging materials (e. g. paper, metal, plastic or non-ferrous metals) and dispose of in accordance with valid national legal requirements.



Viega GmbH & Co. KG
service-technik@viega.de
viega.com

INT • 2021-06 • VPN210152

