

Instructions for Use

Advantix Vario shower channel standing grate, wall

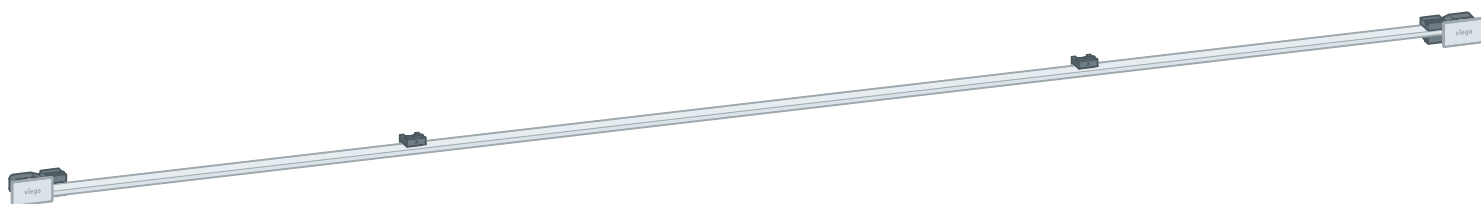

for Advantix Vario shower channel base unit, wall model 4967.10,
4968.10

Model
4967.31

Year built (from)
01/2016

viega

Table of contents

1	About these instructions for use	3
	1.1 Target groups	3
	1.2 Labelling of notes	3
	1.3 About this translated version	4
	1.4 Other applicable documents	4
2	Product information	5
	2.1 Product description	5
	2.1.1 Overview	5
3	Handling	6
	3.1	6
	3.1.1 Installation dimensions	6
	3.2 Assembly	7
	3.2.1 Care	11
	3.3 Disposal	12

1 About these instructions for use

Trade mark rights exist for this document; for further information, go to viega.com/legal.

1.1 Target groups

The information in this instruction manual is directed at the following groups of people:

- Heating and plumbing experts and trained personnel

Individuals without the abovementioned training or qualification are not permitted to mount, install and, if required, maintain this product. This restriction does not extend to possible operating instructions.

The installation of Viega products must take place in accordance with the general rules of engineering and the Viega instructions for use.

1.2 Labelling of notes

Warning and advisory texts are set aside from the remainder of the text and are labelled with the relevant pictographs.



DANGER!

This symbol warns of possible life-threatening injury.



WARNING!

This symbol warns of possible serious injury.



CAUTION!

This symbol warns of possible injury.



NOTICE!

This symbol warns of possible damage to property.



This symbol gives additional information and hints.

1.3 About this translated version

This instruction for use contains important information about the choice of product or system, assembly and commissioning as well as intended use and, if required, maintenance measures. The information about the products, their properties and application technology are based on the current standards in Europe (e.g. EN) and/or in Germany (e.g. DIN/DVGW).

Some passages in the text may refer to technical codes in Europe/Germany. These should serve as recommendations in the absence of corresponding national regulations. The relevant national laws, standards, regulations, directives and other technical provisions take priority over the German/European directives specified in this manual: The information herein is not binding for other countries and regions; as said above, they should be understood as a recommendation.

1.4 Other applicable documents

This instruction for use describes the mounting of an accessory set for an Advantix Vario shower channel in rough steps.



The instructions for use of the Advantix Vario shower channel must also be strictly observed for the mounting of the accessory set.

2 Product information

2.1 Product description

The standing grate set may be mounted only in Viega Advantix Vario shower channel base units, wall model 4967.10 and 4968.10.

Model	4967.31
Article	736 576
Description	Advantix Vario standing grate

2.1.1 Overview

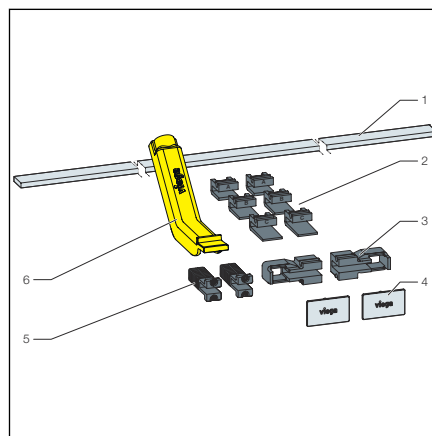

Fig. 1: Scope of delivery

- 1 Standing grate
- 2 Standing grade support
- 3 Standing grade holder
- 4 Cover caps
- 5 Standing grade insert
- 6 Mounting tool

3 Handling

3.1

3.1.1 Installation dimensions

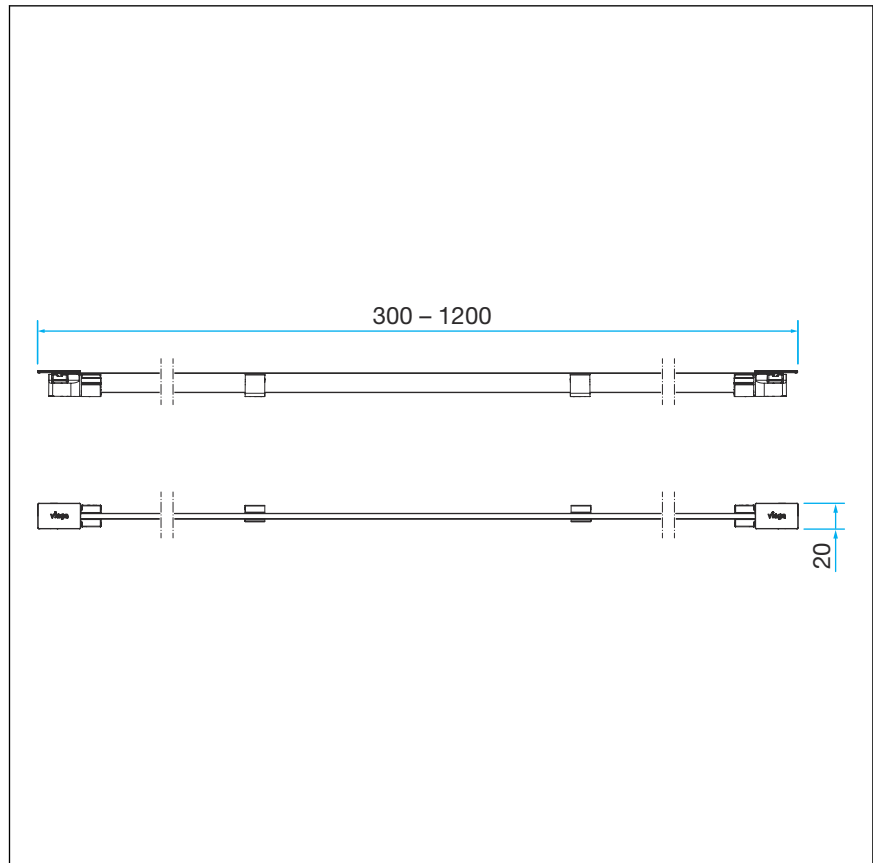
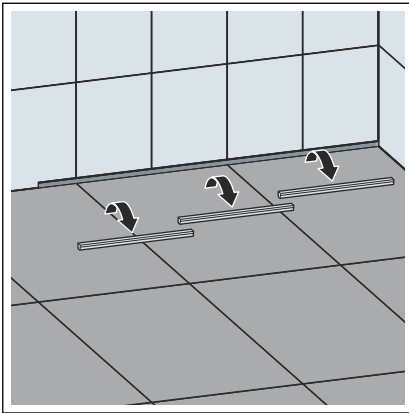
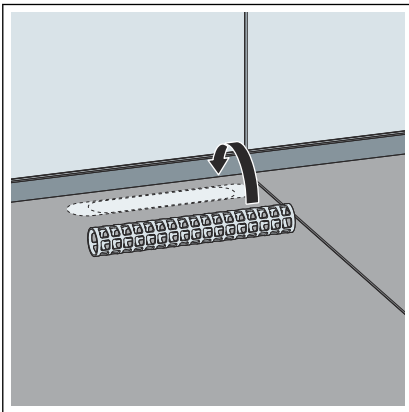

Fig. 2: Installation dimensions

3.2 Assembly



➤ Remove the site protection inserts.



➤ Fit the sieve insert in the area of the drain hole.

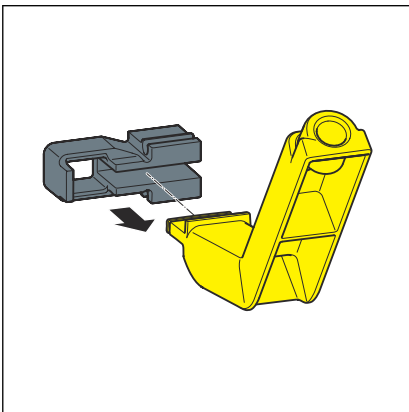

➤ Assembly example on left-hand side: Push the standing grate holder onto the mounting tool.

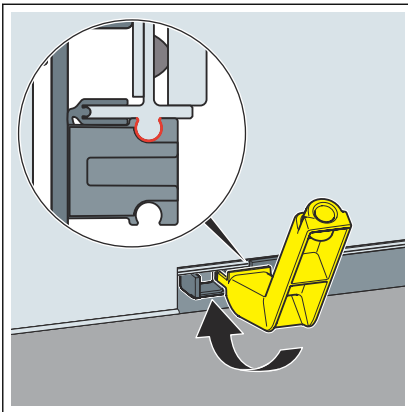

► Mount the standing grate holder on the tile edge profile using the mounting tool.

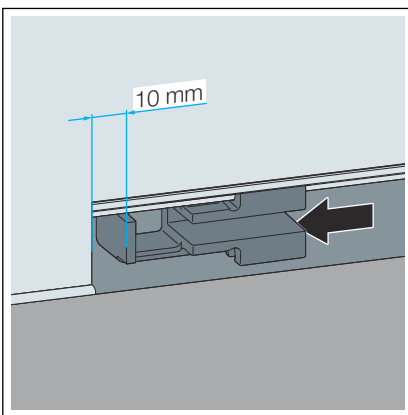

► Push the grate holder until it is 10 mm away from the tile surface.

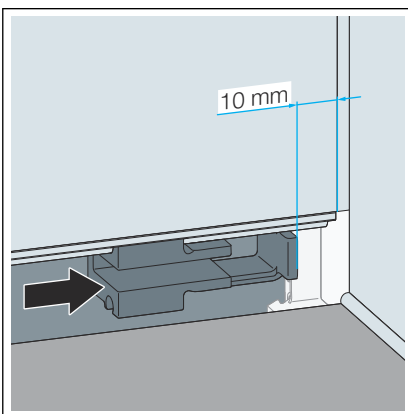

► Push the grate holder until it is 10 mm away from the tile surface.

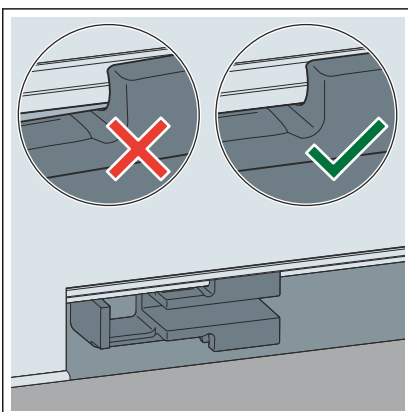

► Check that the standing grate holder is correctly positioned.

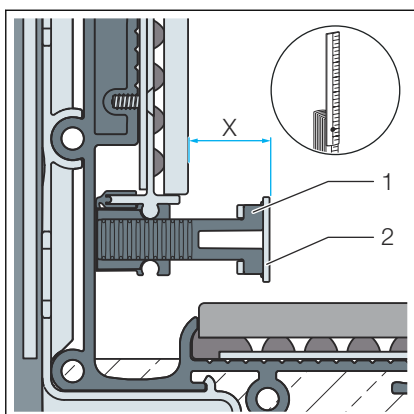

► Determine the length to be cut off.

X = length to be shortened

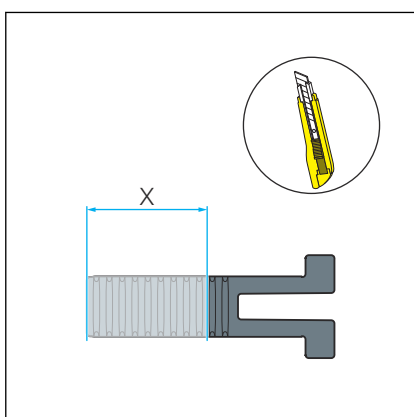

► Cut off length X.

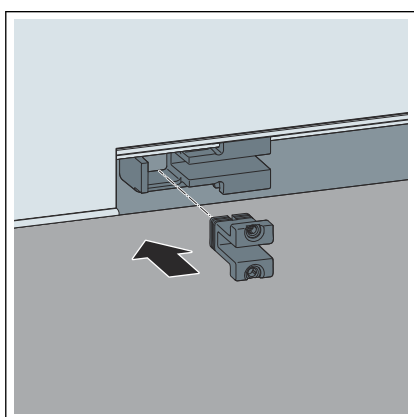

► Insert the standing grade support.

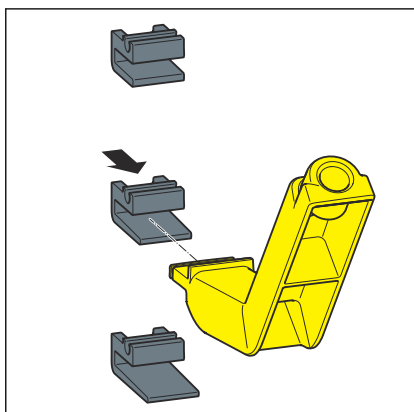

► Push the standing grade support onto the mounting tool.

Select the standing grade support length from the list:

- Standing grade support A at surface height (tiles and adhesive) 10-16 mm
- Standing grade support B at surface height (tiles and adhesive) 15-23 mm
- Standing grade support C at surface height (tiles and adhesive) 23-28 mm

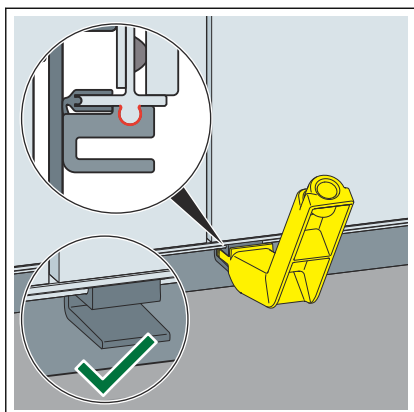

- Mount the standing grate support on the tile edge profile using the mounting tool.
- Check the standing grate support is correctly positioned.

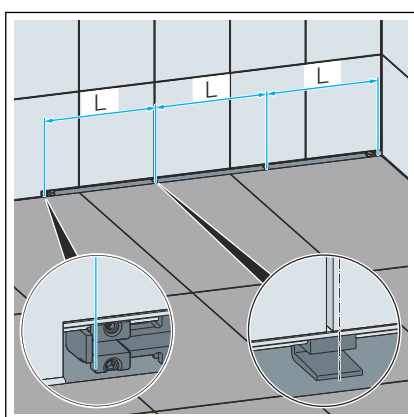

- Distribute the supports evenly.

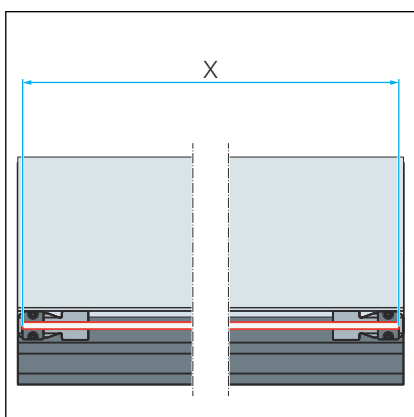

- Determine the standing grate length.

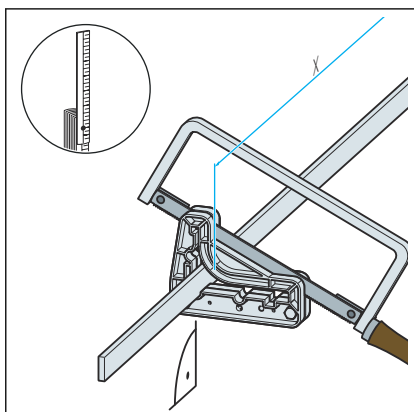

- Shorten and deburr the standing grate.

NOTICE! The standing grate must not be shortened with a cutting disc (angle grinder).

If required, shorten the standing grate with a handsaw and deburr.

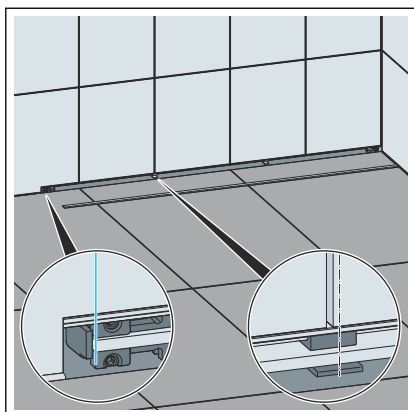

► Insert the standing grate.

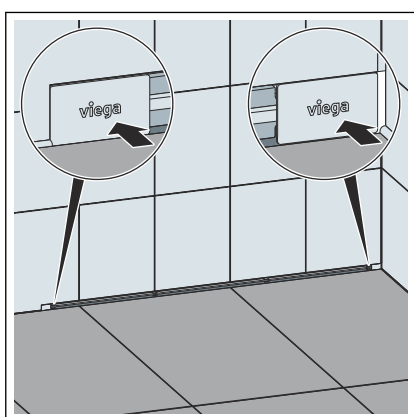

► Press the cover caps on.

3.2.1 Care



NOTICE! Risk of damage due to unsuitable cleaning agent.

The following cleaning agents can damage chrome-plated surfaces and therefore may not be used:

- scouring agent
- abrasive sponges
- lime, plaster or cement dissolver
- solvents or other acidic cleaning agents

Normal soap or a mild cleaning agent can be used for regular care and prevention of lime scale. Under no circumstances should scouring agent or scratching objects be used.

Strong stains, even around the drain unit and the siphon, can be removed using typical household cleaner. Please note that the cleaning agent must be rinsed off thoroughly with clear water after the prescribed soaking time. There should be no residue on the components.

3.3 Disposal

Separate the product and packaging materials (e. g. paper, metal, plastic or non-ferrous metals) and dispose of in accordance with valid national legal requirements.



Viega GmbH & Co. KG
service-technik@viega.de
viega.com

INT • 2022-08 • VPN200027

