

Instructions for Use

Prevista Dry Plus mounting bracket

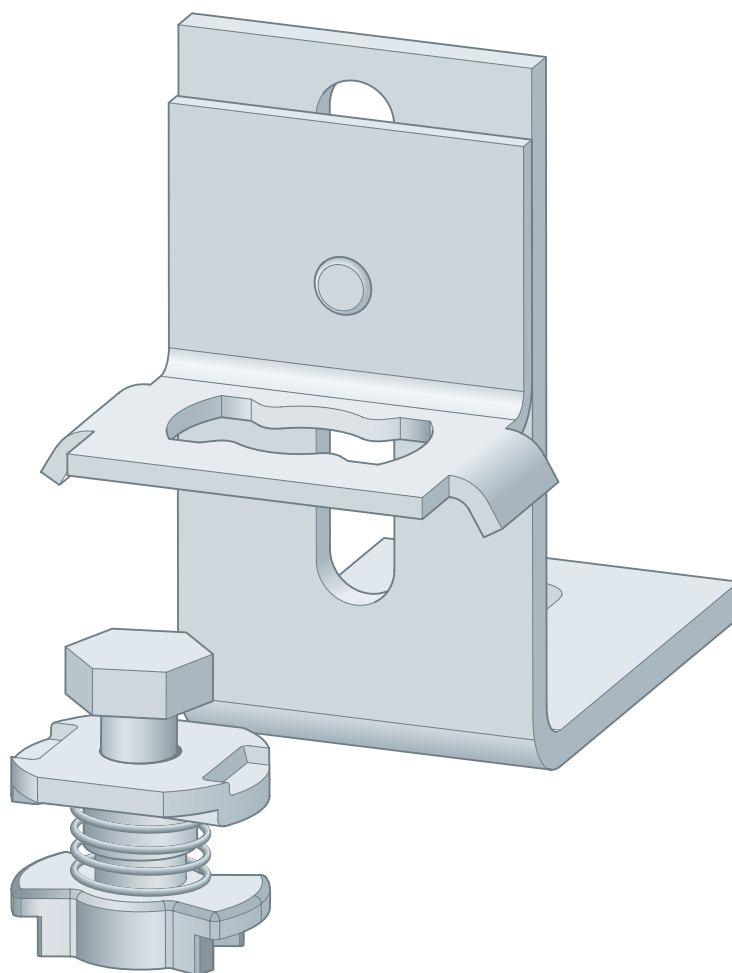

for wall and floor connection of prefabricated wall

Model
8415

Year built (from)
04/2004

viega

Table of contents

1	About these instructions for use	3
	1.1 Target groups	3
	1.2 Labelling of notes	3
	1.3 About this translated version	4
2	Product information	5
	2.1 Intended use	5
	2.1.1 Areas of use	5
	2.2 Product description	5
	2.2.1 Overview	5
3	Handling	6
	3.1 Assembly information	6
	3.1.1 Installation dimensions	6
	3.2 Assembly	7
	3.3 Disposal	8

1 About these instructions for use

Trade mark rights exist for this document; for further information, go to viega.com/legal.

1.1 Target groups

The information in this instruction manual is directed at the following groups of people:

- Heating and plumbing experts and trained personnel

Individuals without the abovementioned training or qualification are not permitted to mount, install and, if required, maintain this product. This restriction does not extend to possible operating instructions.

The installation of Viega products must take place in accordance with the general rules of engineering and the Viega instructions for use.

1.2 Labelling of notes

Warning and advisory texts are set aside from the remainder of the text and are labelled with the relevant pictographs.



DANGER!

This symbol warns of possible life-threatening injury.



WARNING!

This symbol warns of possible serious injury.



CAUTION!

This symbol warns of possible injury.



NOTICE!

This symbol warns of possible damage to property.



This symbol gives additional information and hints.

1.3 About this translated version

This instruction for use contains important information about the choice of product or system, assembly and commissioning as well as intended use and, if required, maintenance measures. The information about the products, their properties and application technology are based on the current standards in Europe (e.g. EN) and/or in Germany (e.g. DIN/DVGW).

Some passages in the text may refer to technical codes in Europe/Germany. These should serve as recommendations in the absence of corresponding national regulations. The relevant national laws, standards, regulations, directives and other technical provisions take priority over the German/European directives specified in this manual: The information herein is not binding for other countries and regions; as said above, they should be understood as a recommendation.

2 Product information

2.1 Intended use

2.1.1 Areas of use

The Prevista Dry Plus mounting bracket is intended for the fixing of a pre-fabricated Prevista Dry Plus pre-wall construction.

2.2 Product description

2.2.1 Overview

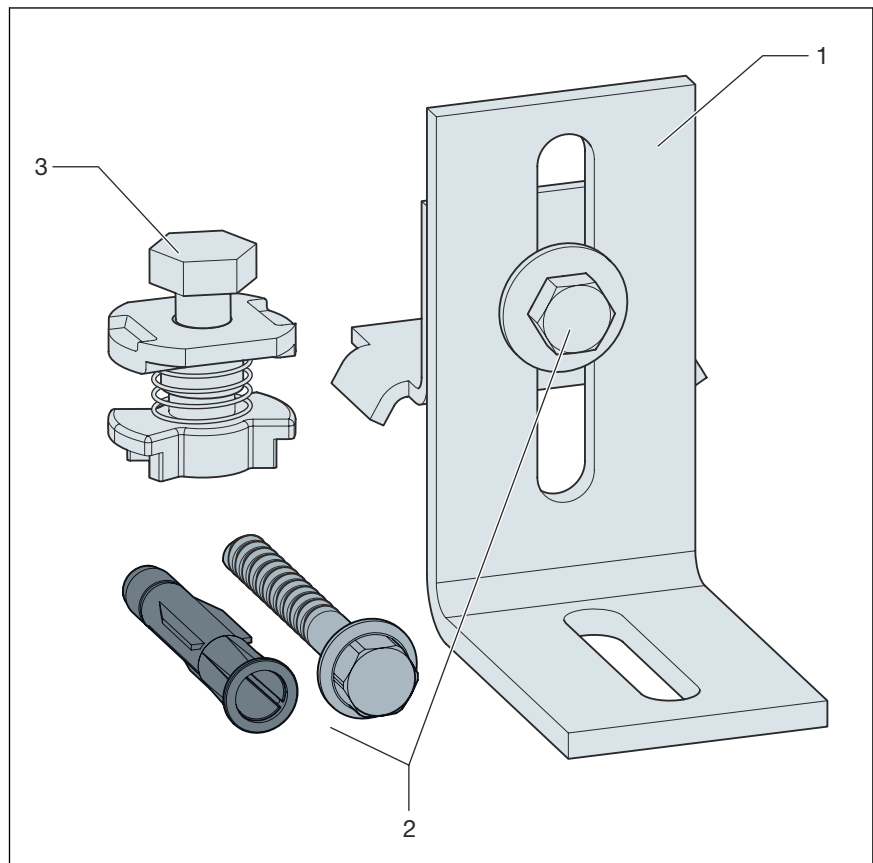

- 1 Mounting bracket
- 2 Fixing material
- 3 Slot nut

3 Handling

3.1 Assembly information

3.1.1 Installation dimensions

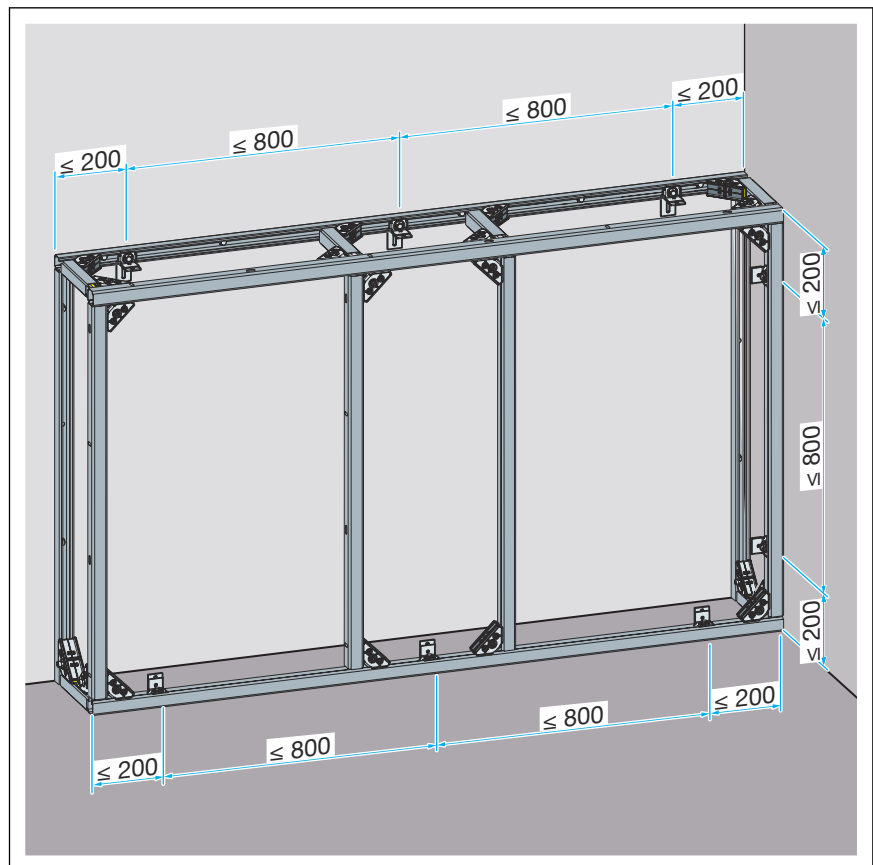

Fig. 1: Fixing distances

Plan the distances between the individual mounting brackets before mounting.

The distance to the external rails or the floor may not exceed 200 mm.

The distance between the individual brackets must not exceed 800 mm.

3.2 Assembly



For this, observe the instructions for pre-fabrication of the pre-wall in the Prevista Dry Plus modular system instructions for use.



- Position the pre-fabricated wall in the desired position.

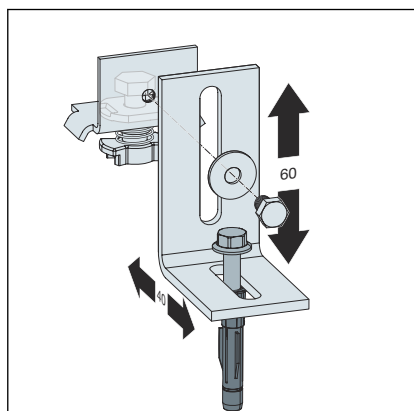

- Set the mounting bracket to the required dimensions.

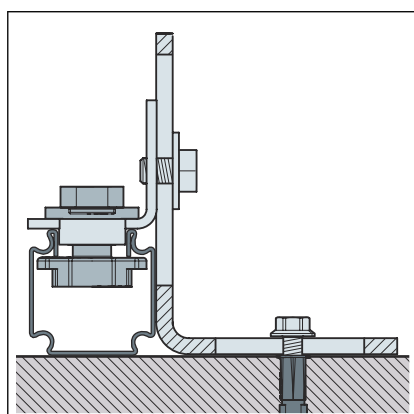

- Attach the mounting bracket flush to the floor or the wall and the rail.
 - In addition, attach the slot nut onto the open side of the rail:
 - Insert the slot nut into the opening.
 - Push the slot nut in slightly and turn by 90°.
- The slot nut is fastened in the rail and its position can still be adjusted, if necessary.
- Tighten the slot nut with a ring spanner (size 17).

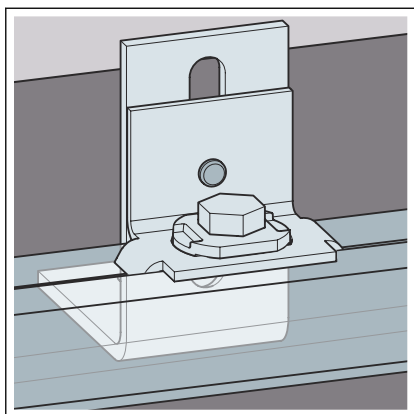

- Screw the long side of the bracket on the floor or to the wall.

3.3 Disposal

Separate the product and packaging materials (e. g. paper, metal, plastic or non-ferrous metals) and dispose of in accordance with valid national legal requirements.



Viega GmbH & Co. KG
service-technik@viega.de
viega.com

INT • 2022-08 • VPN200542

